

NRÇ-05 AYARLI GÜÇ KAYNAĞI MONTAJI

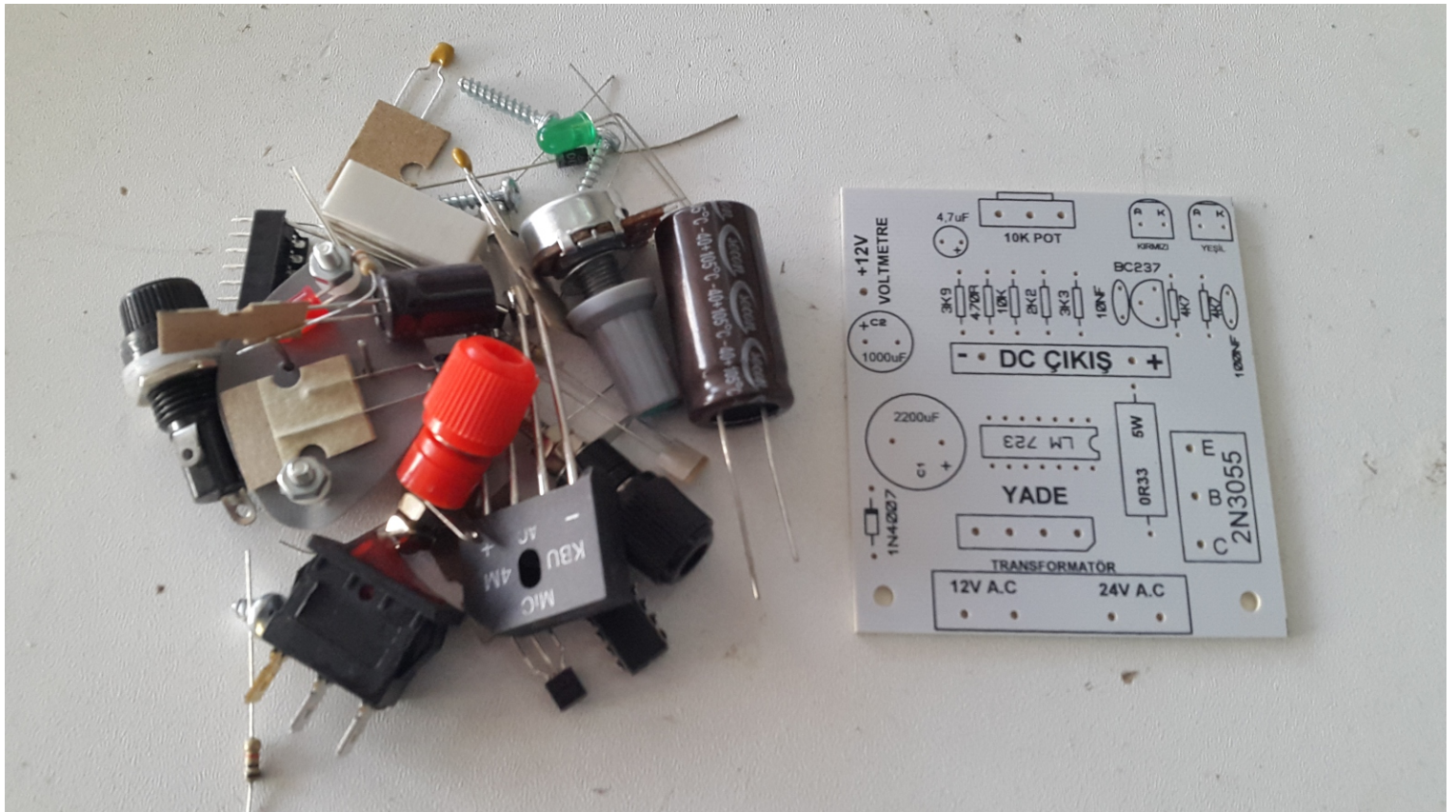

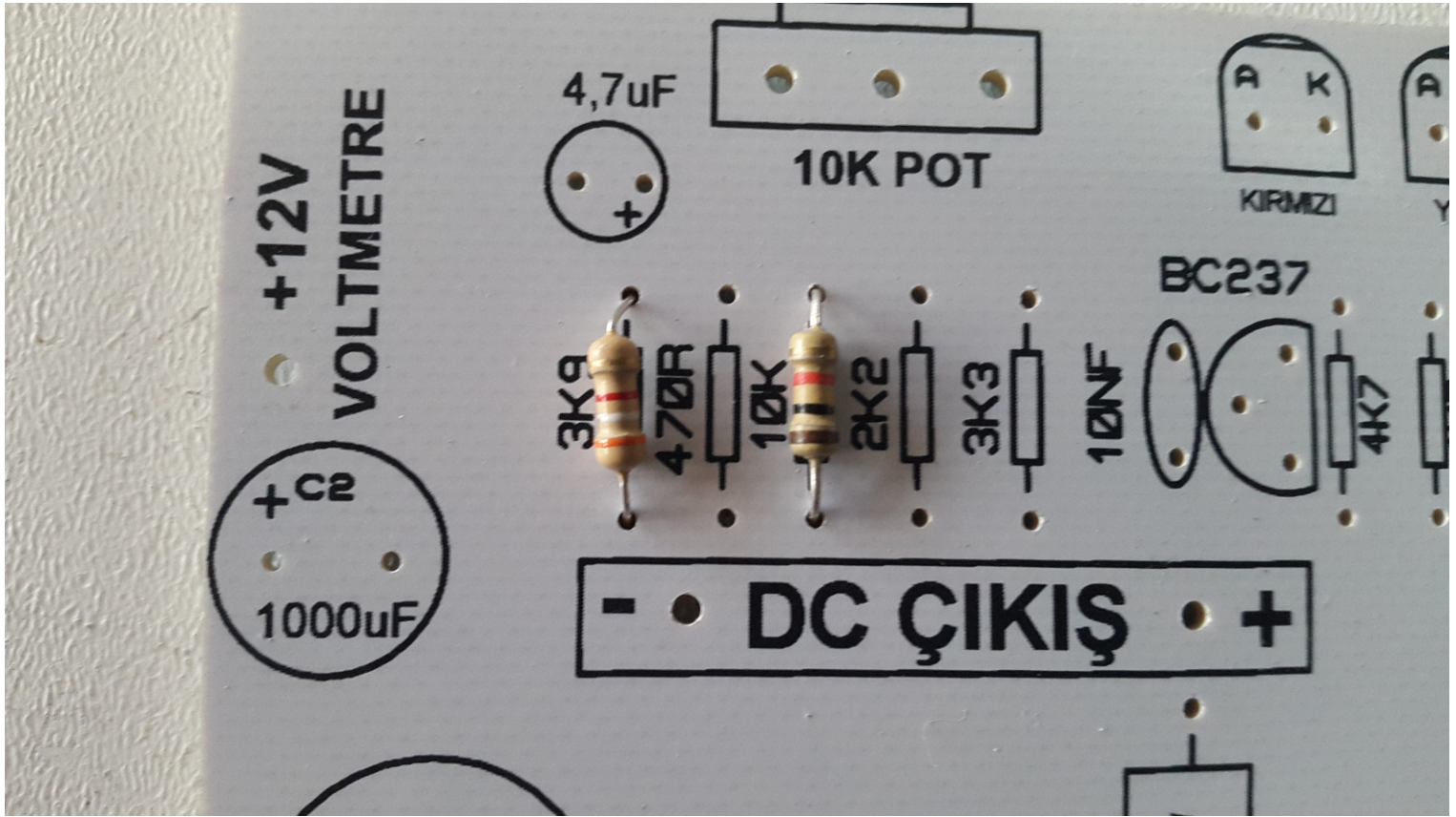

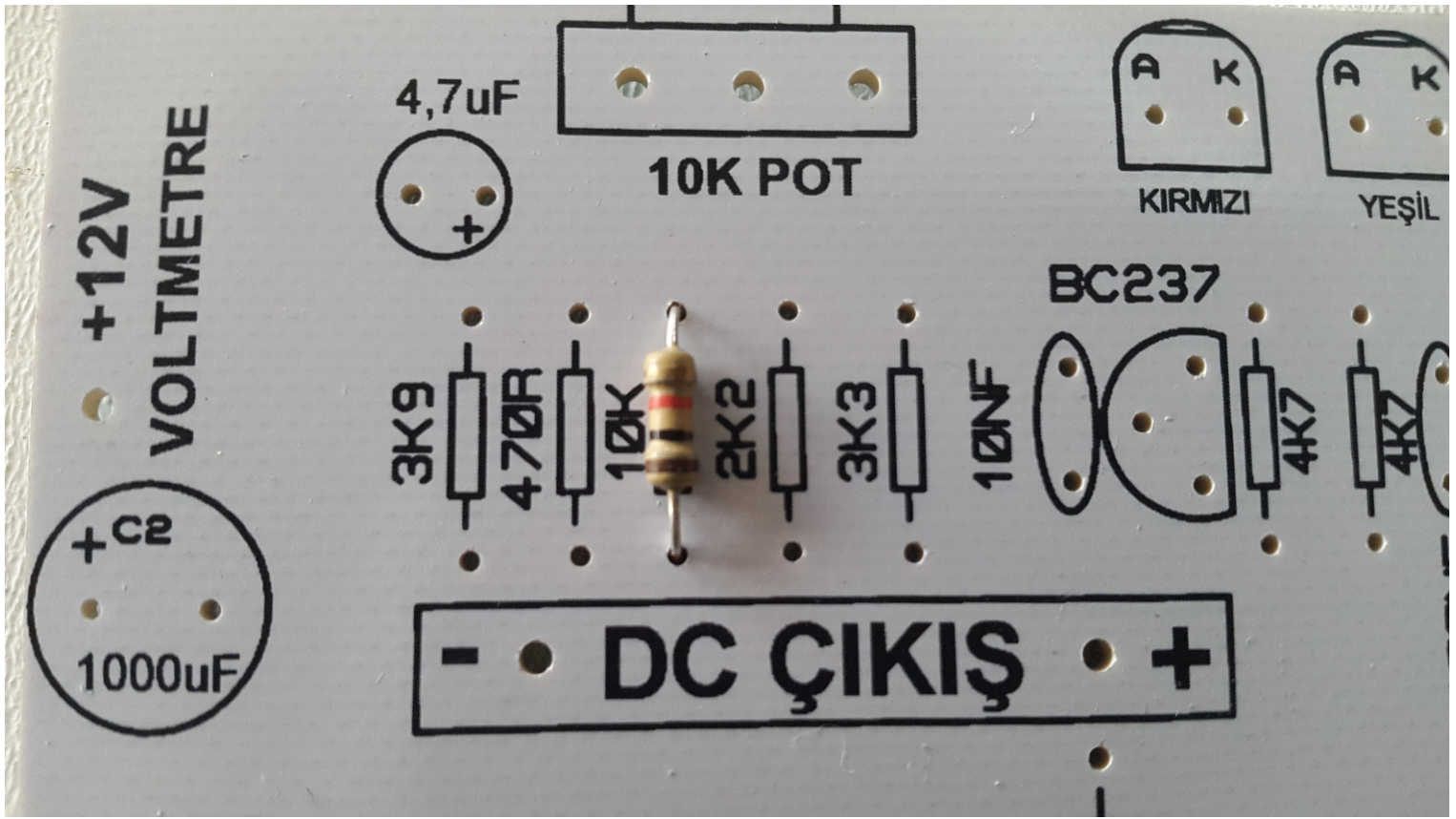

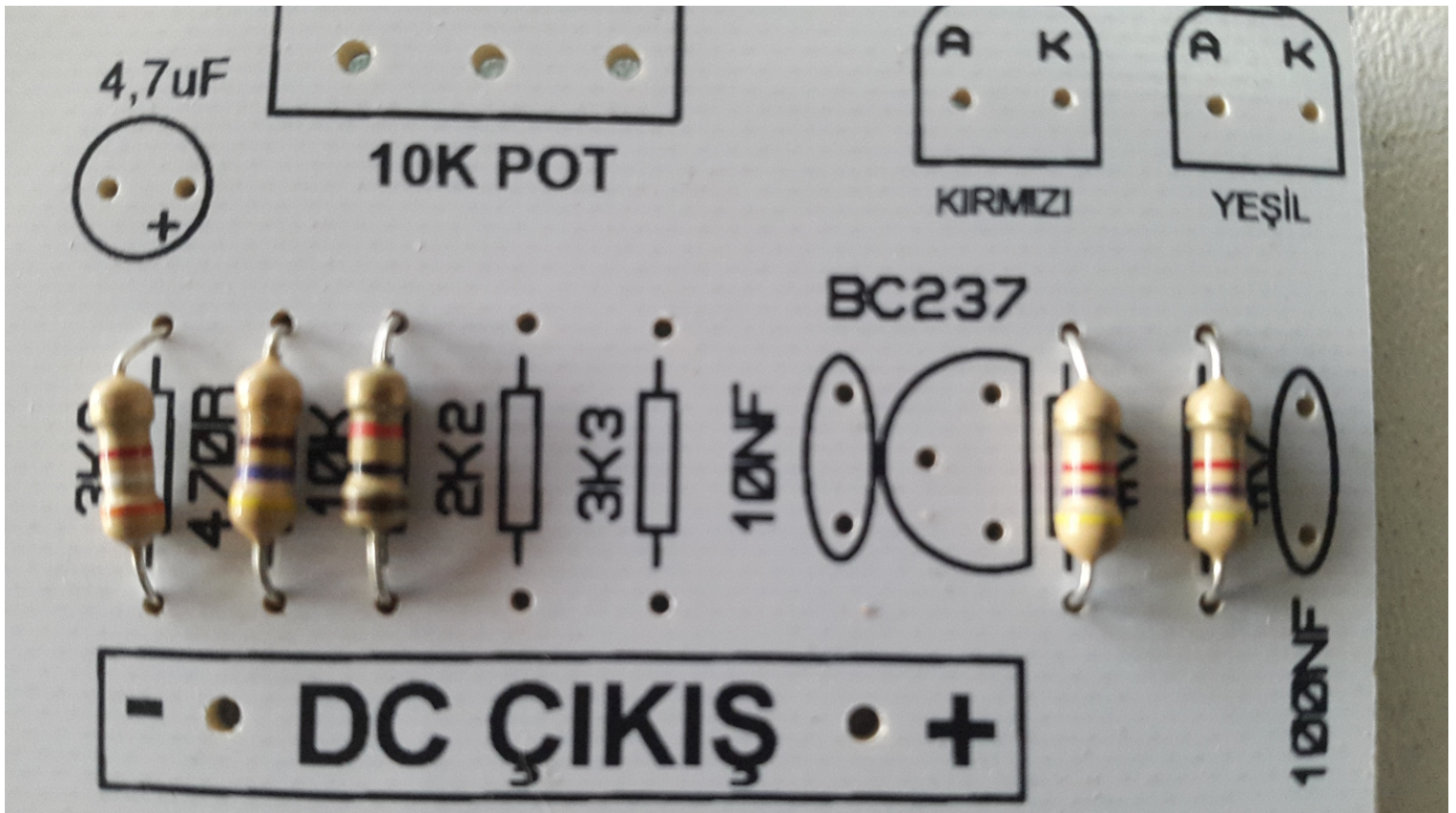
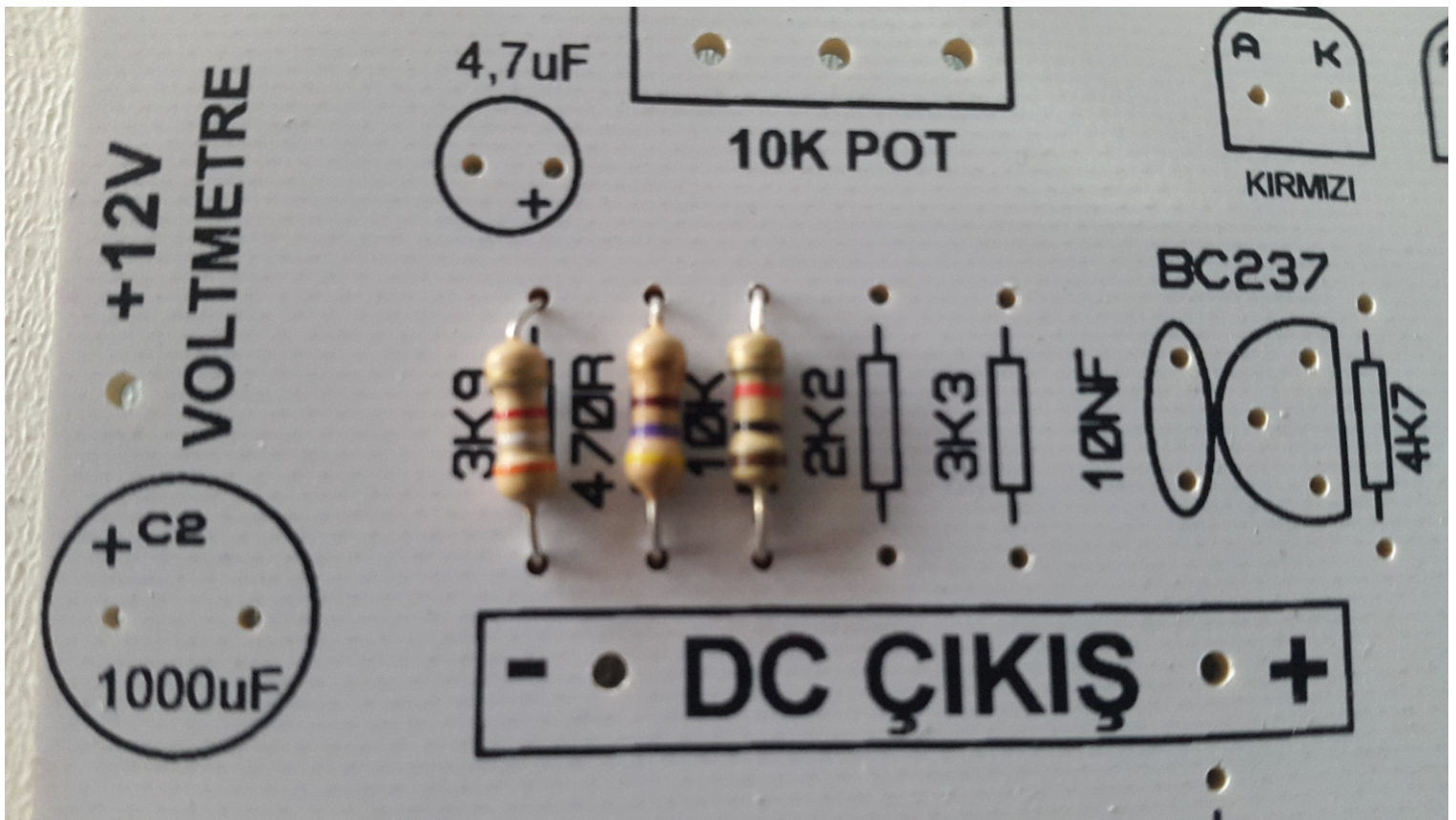

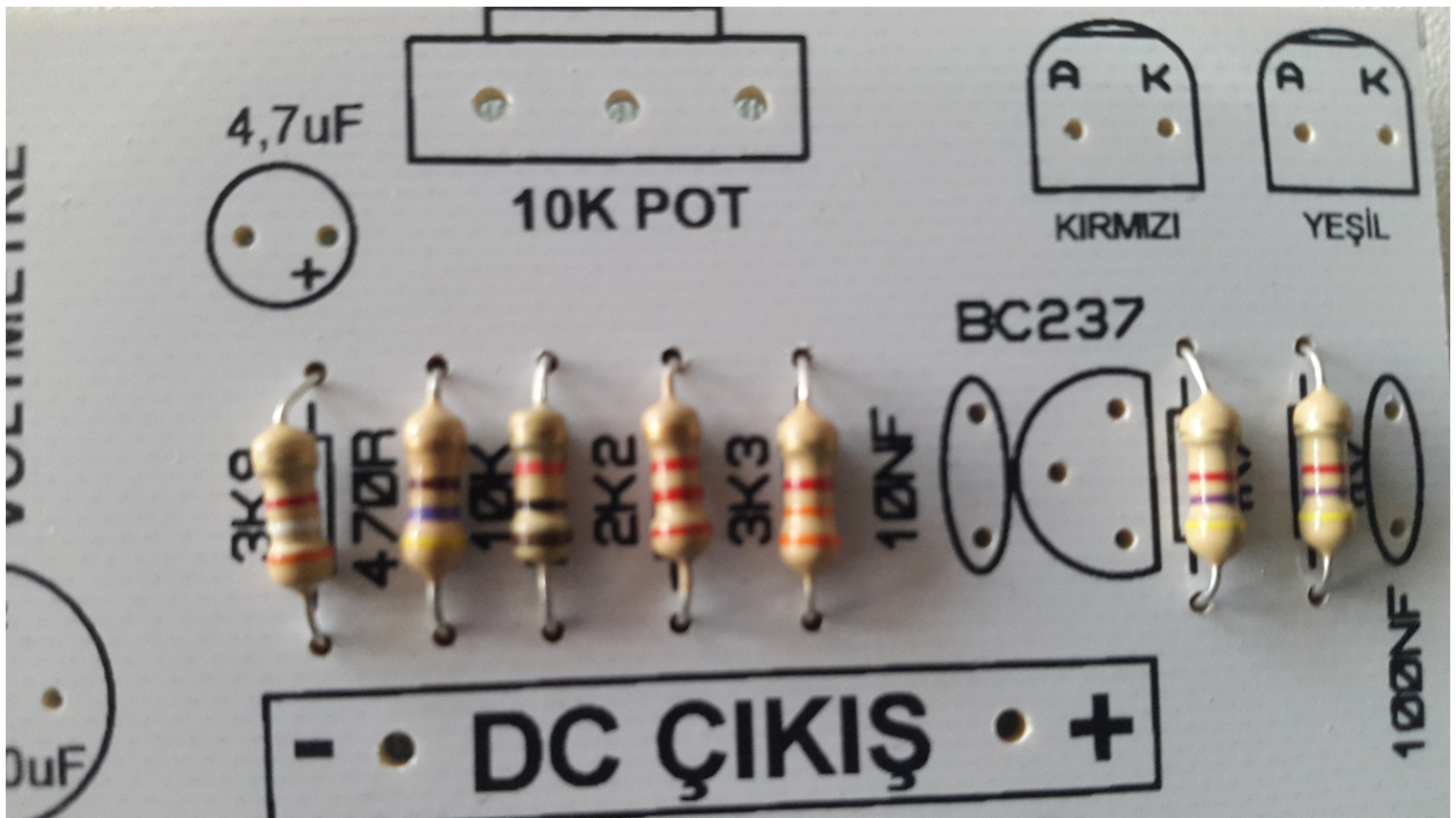
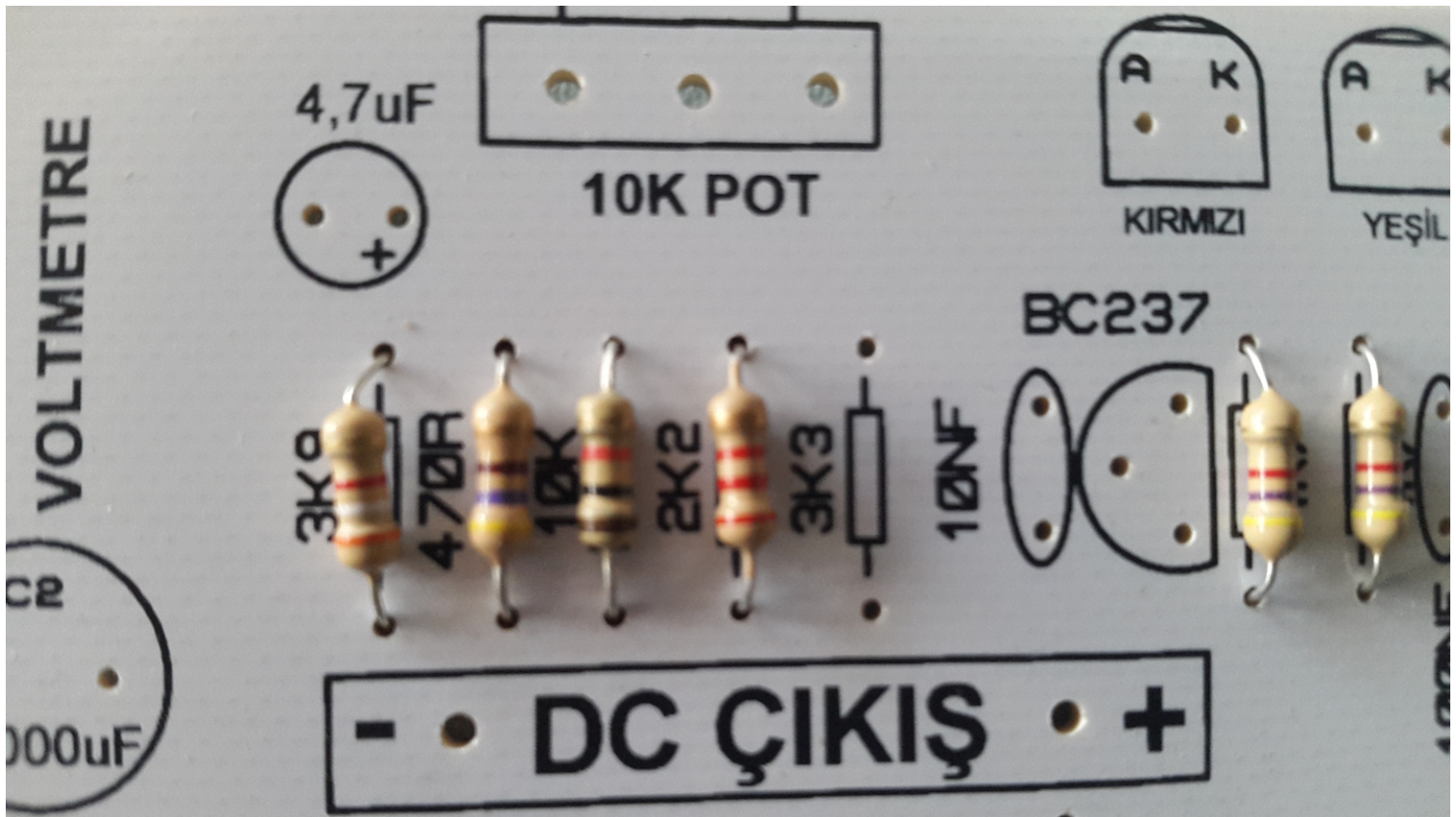

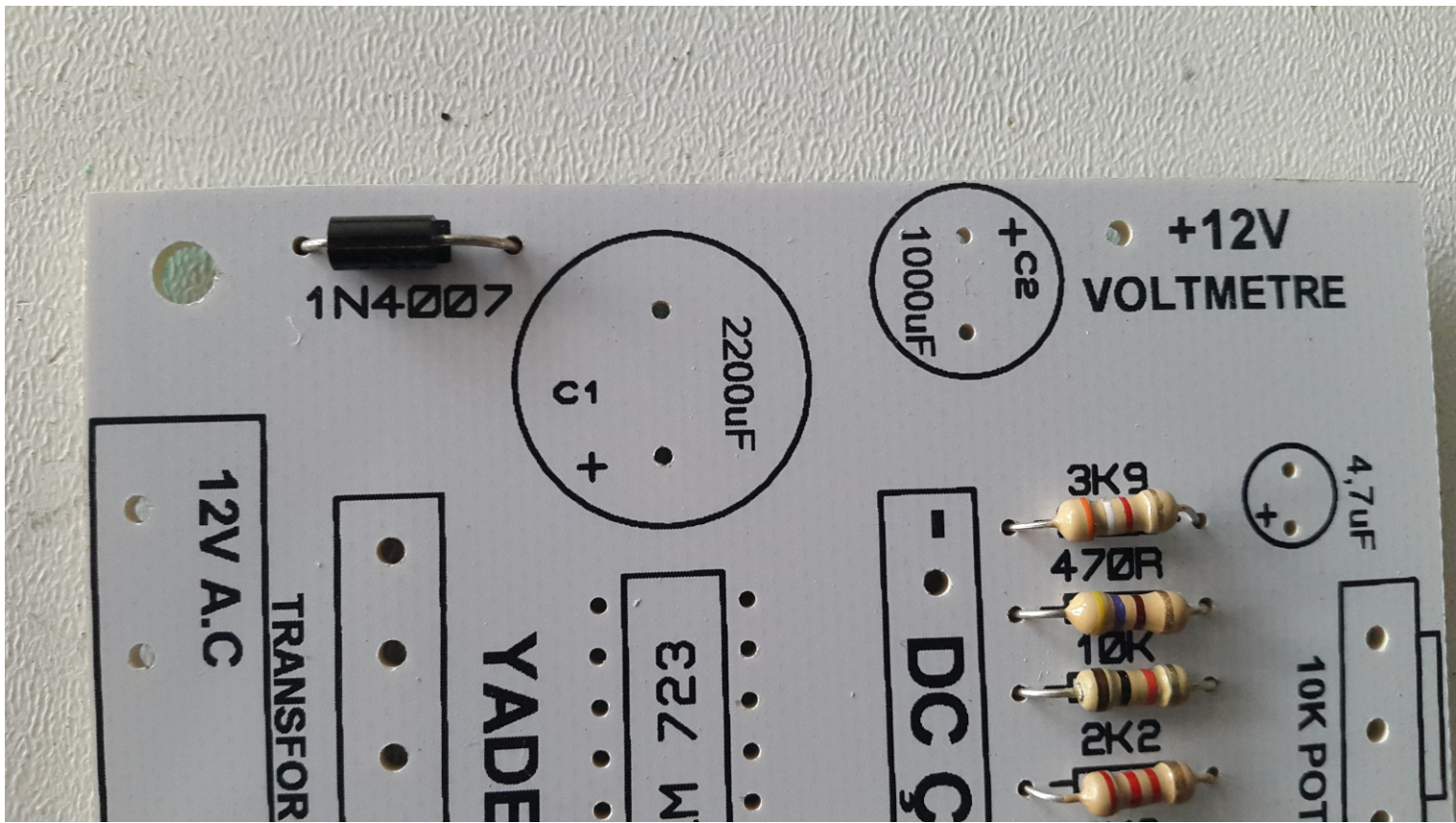

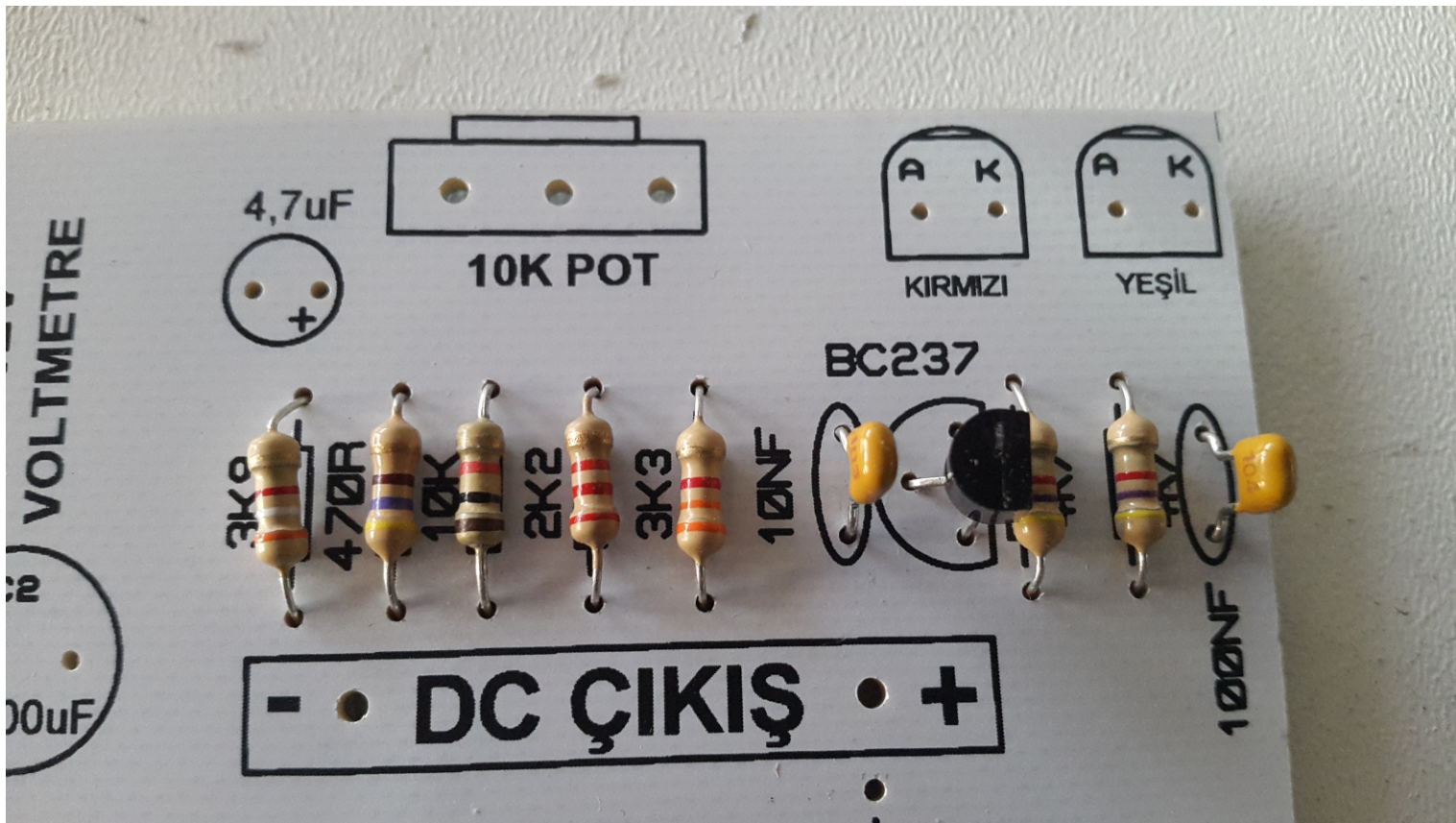
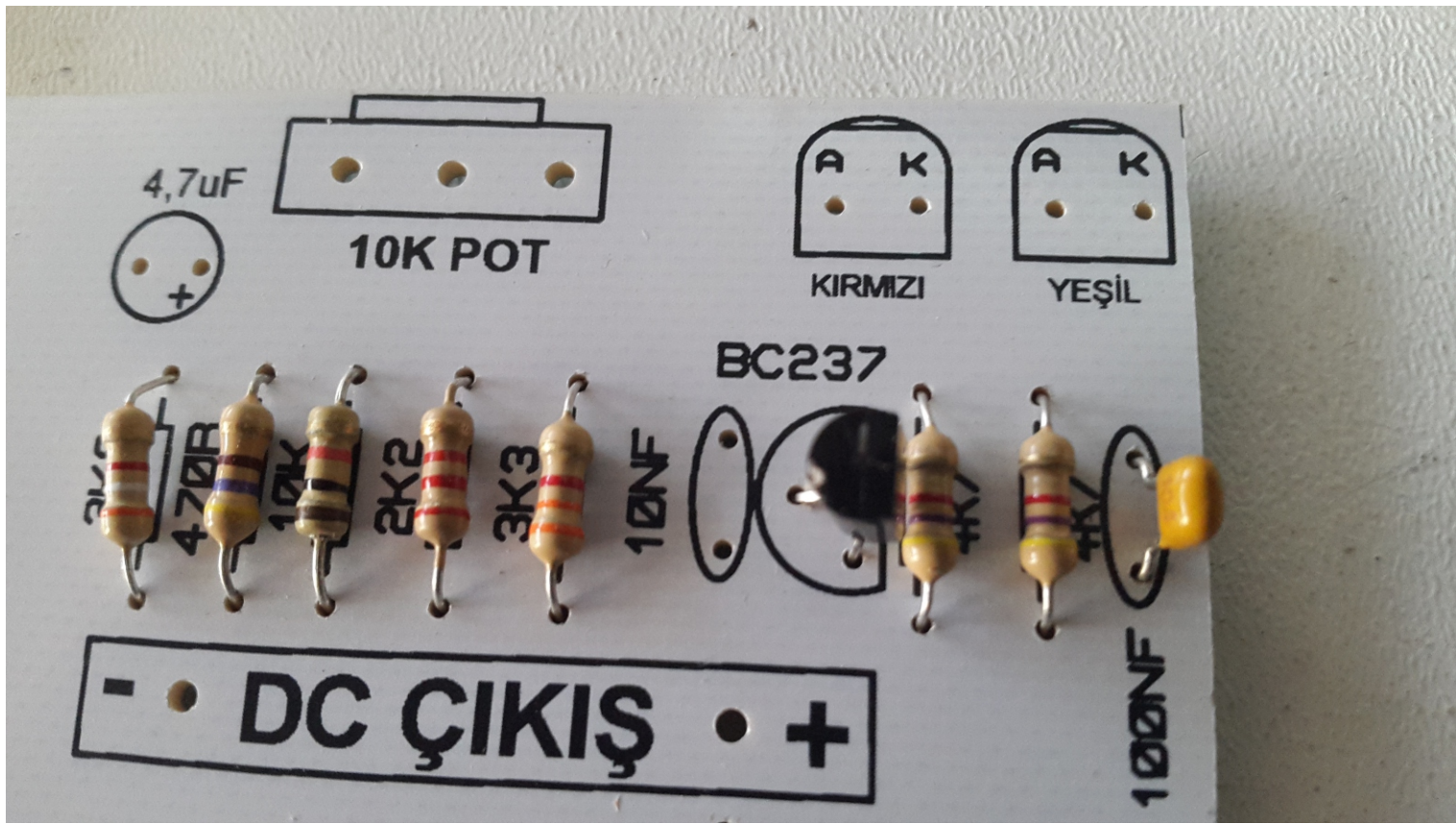

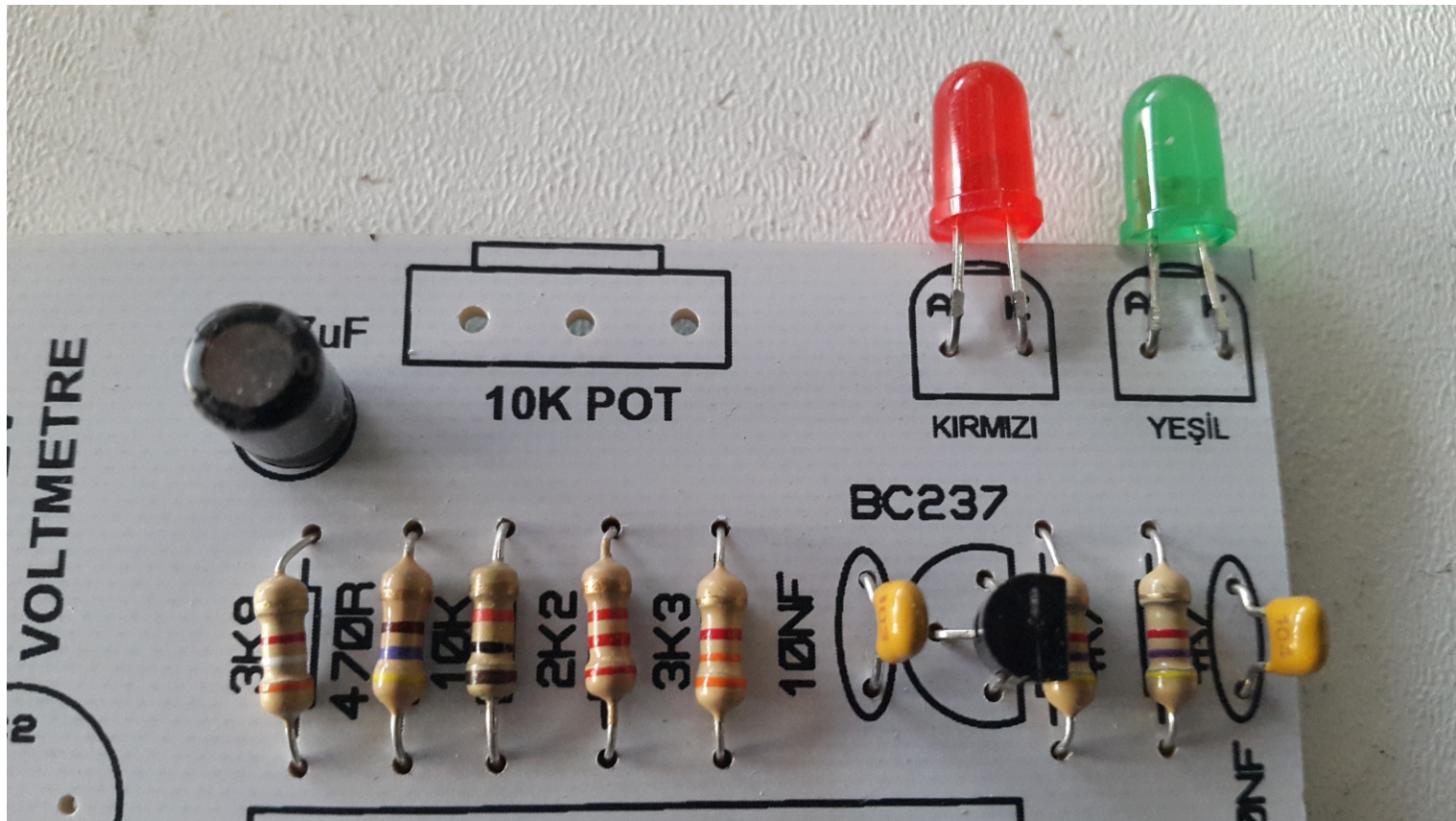
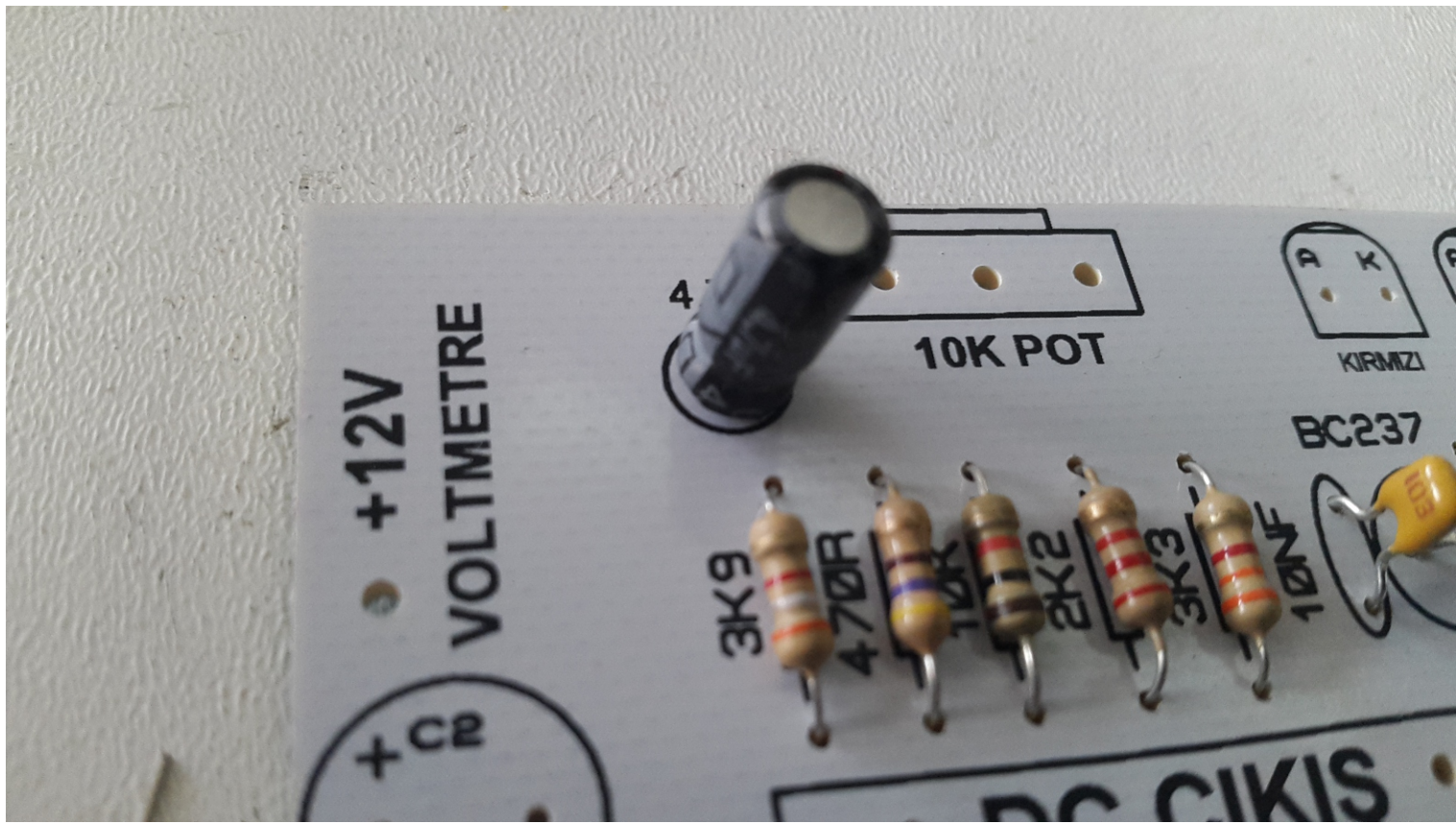

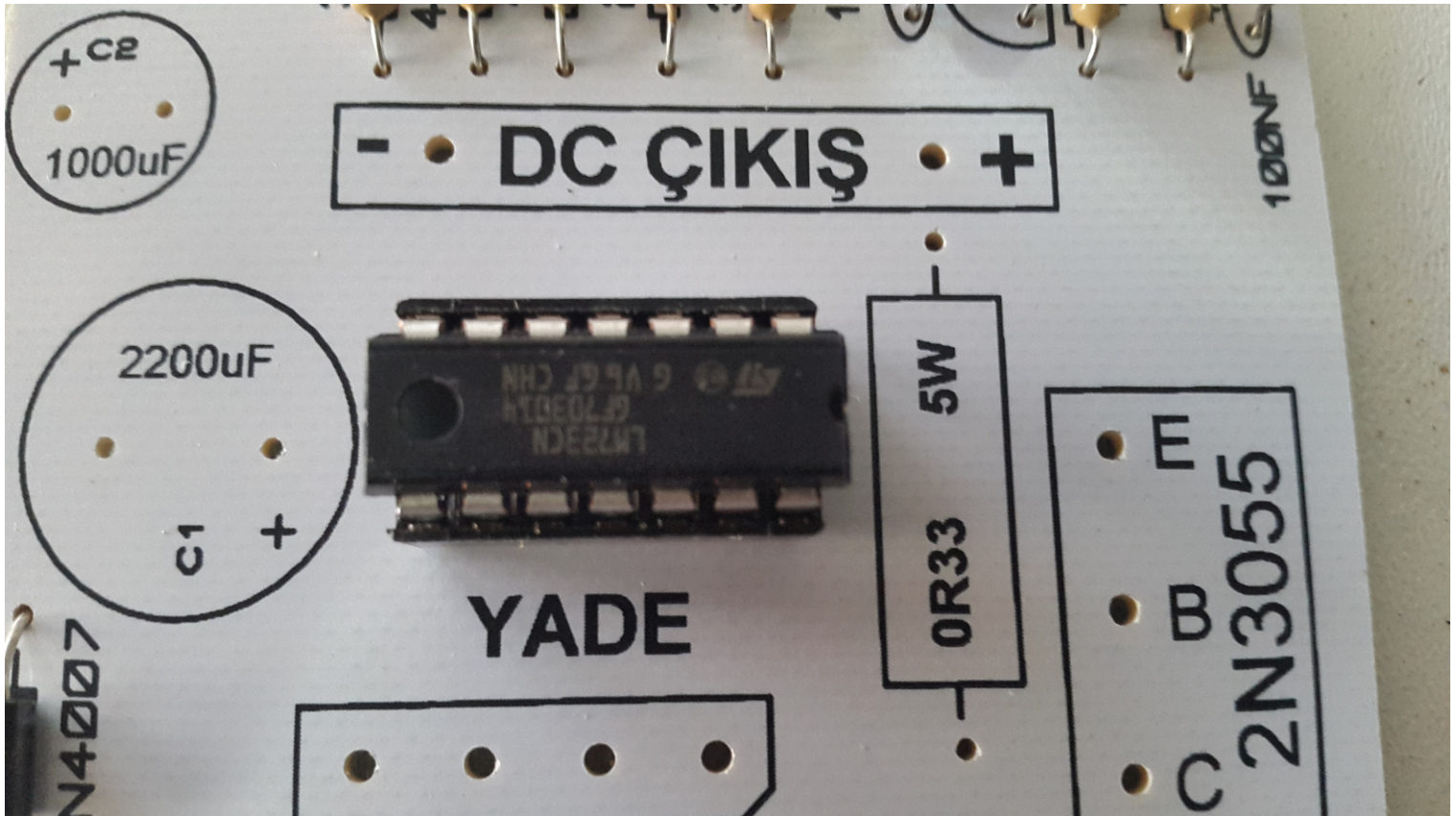
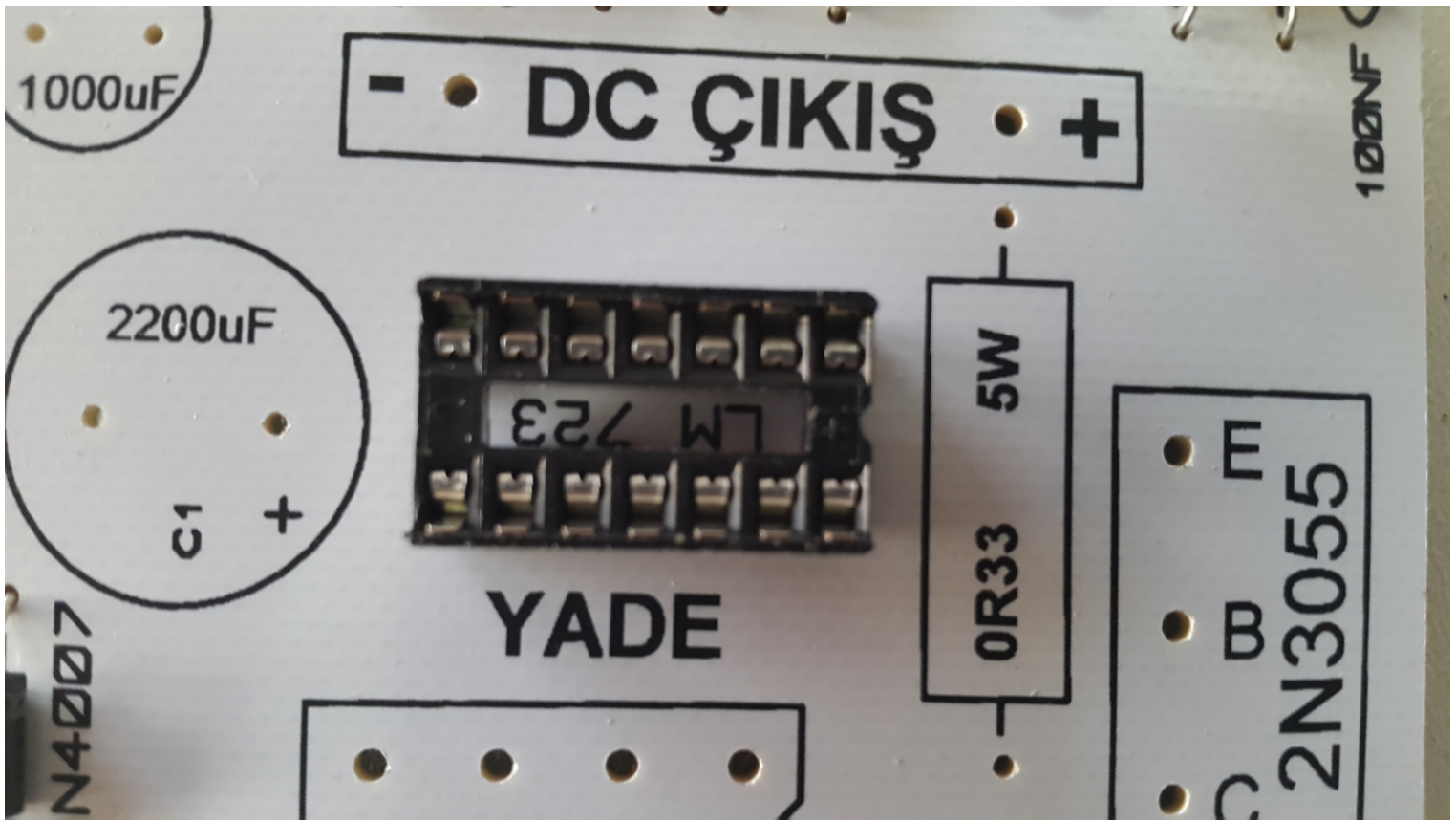

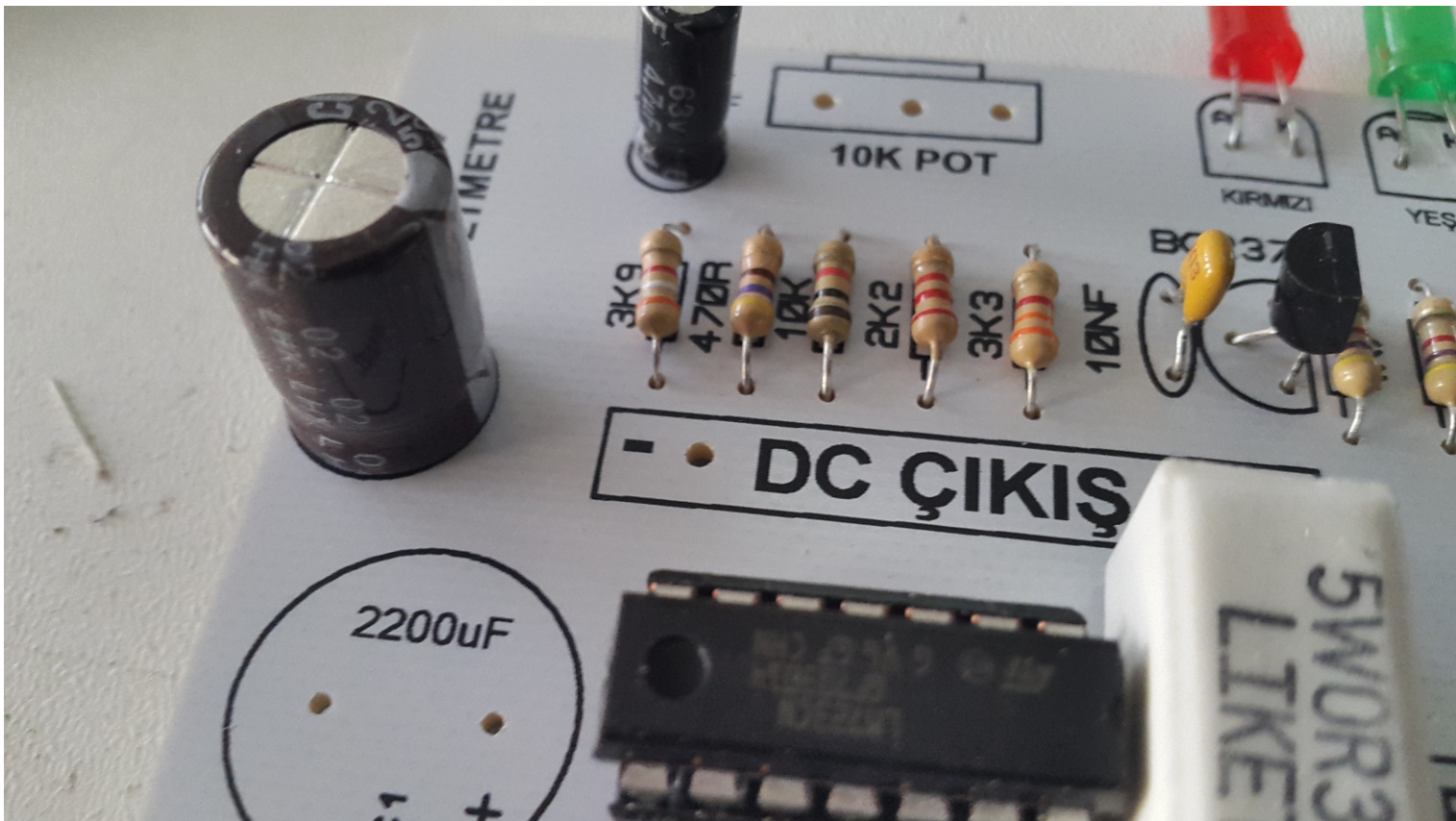
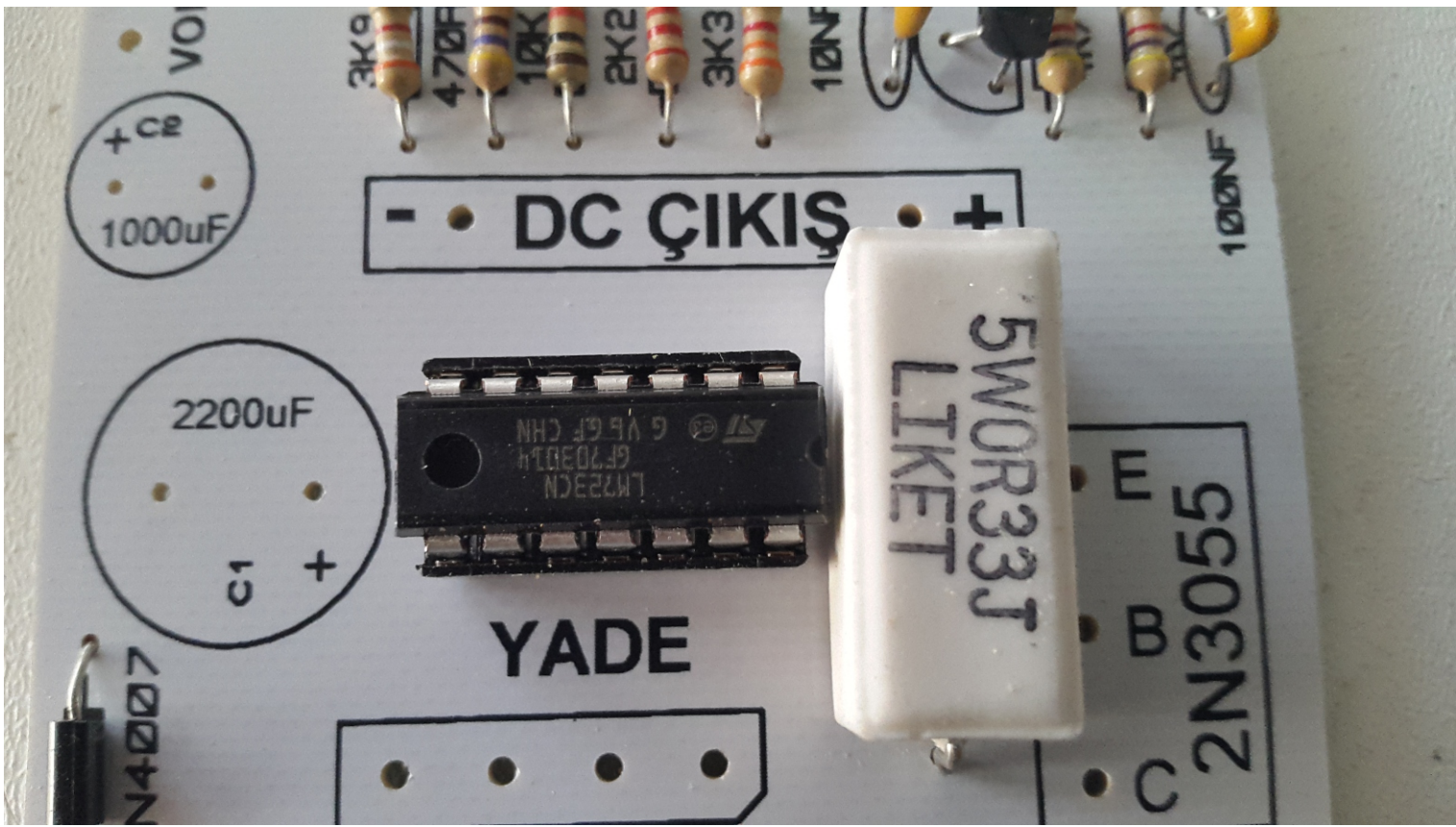





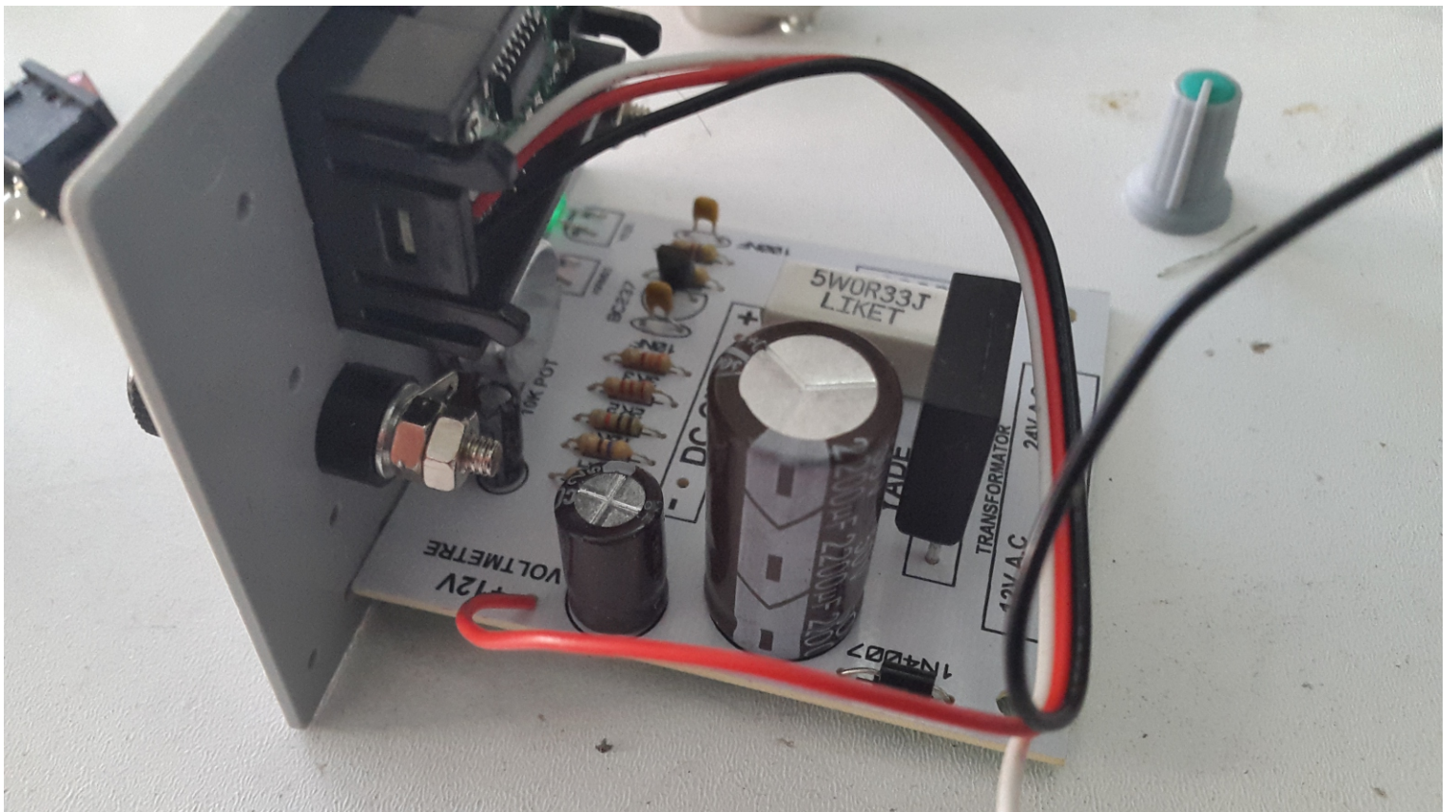
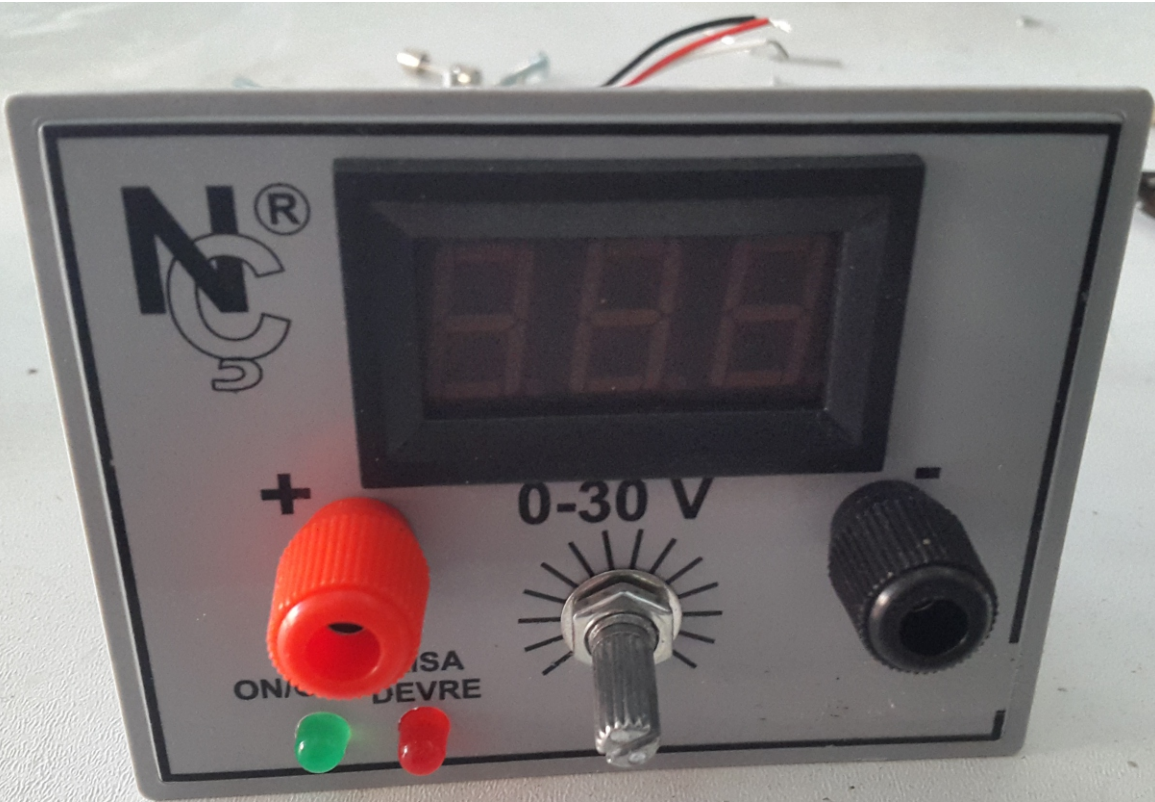

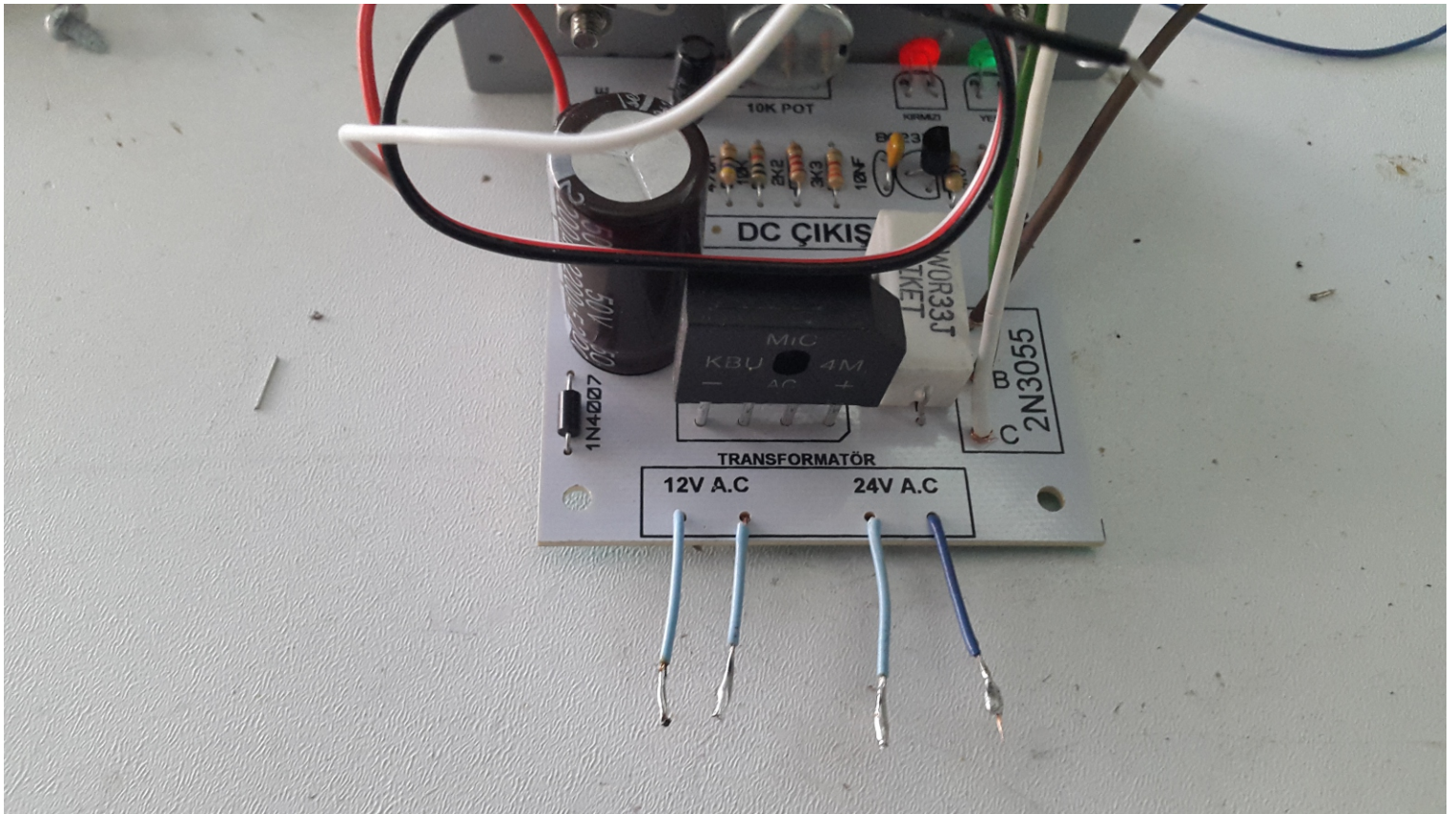
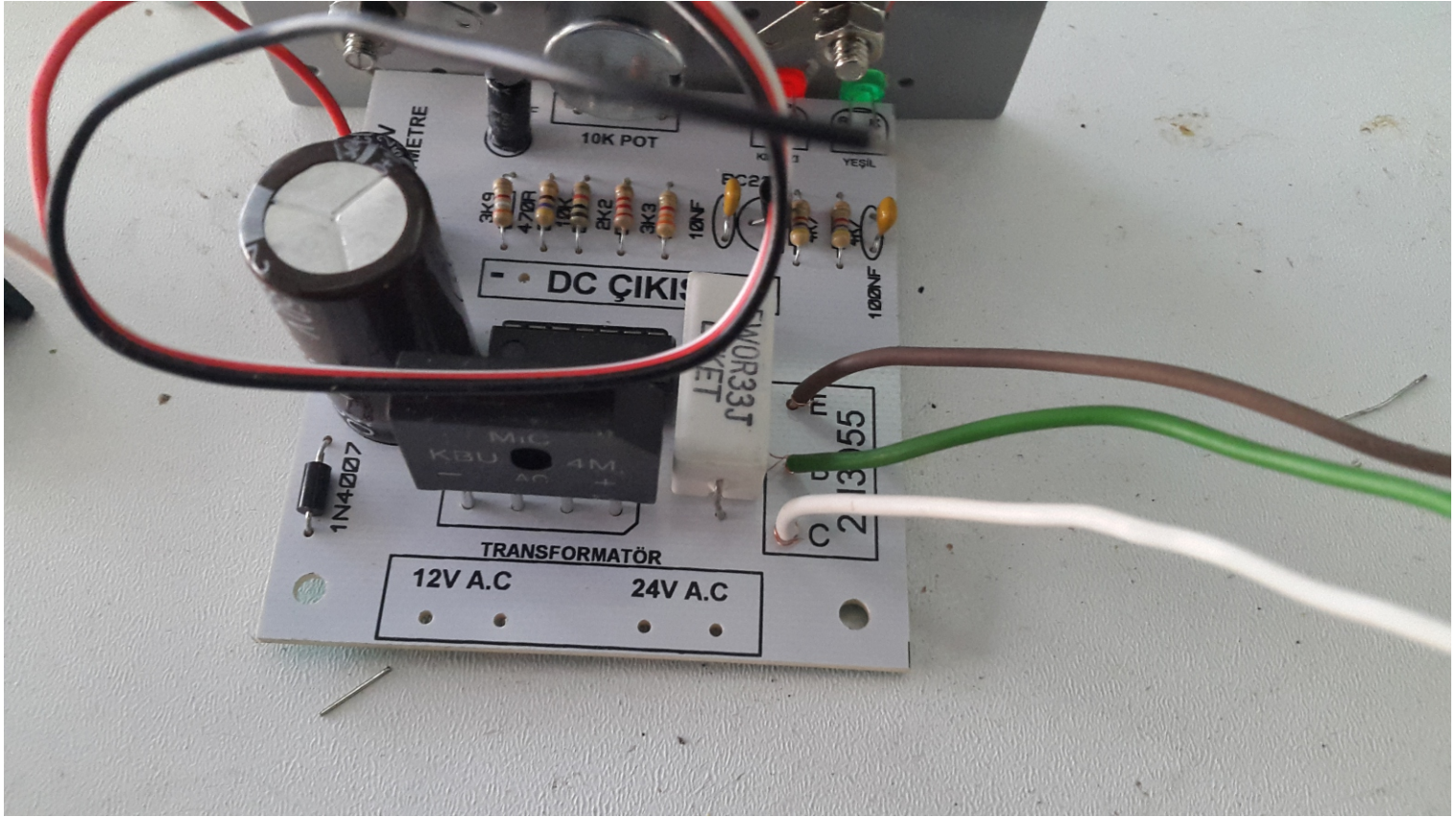

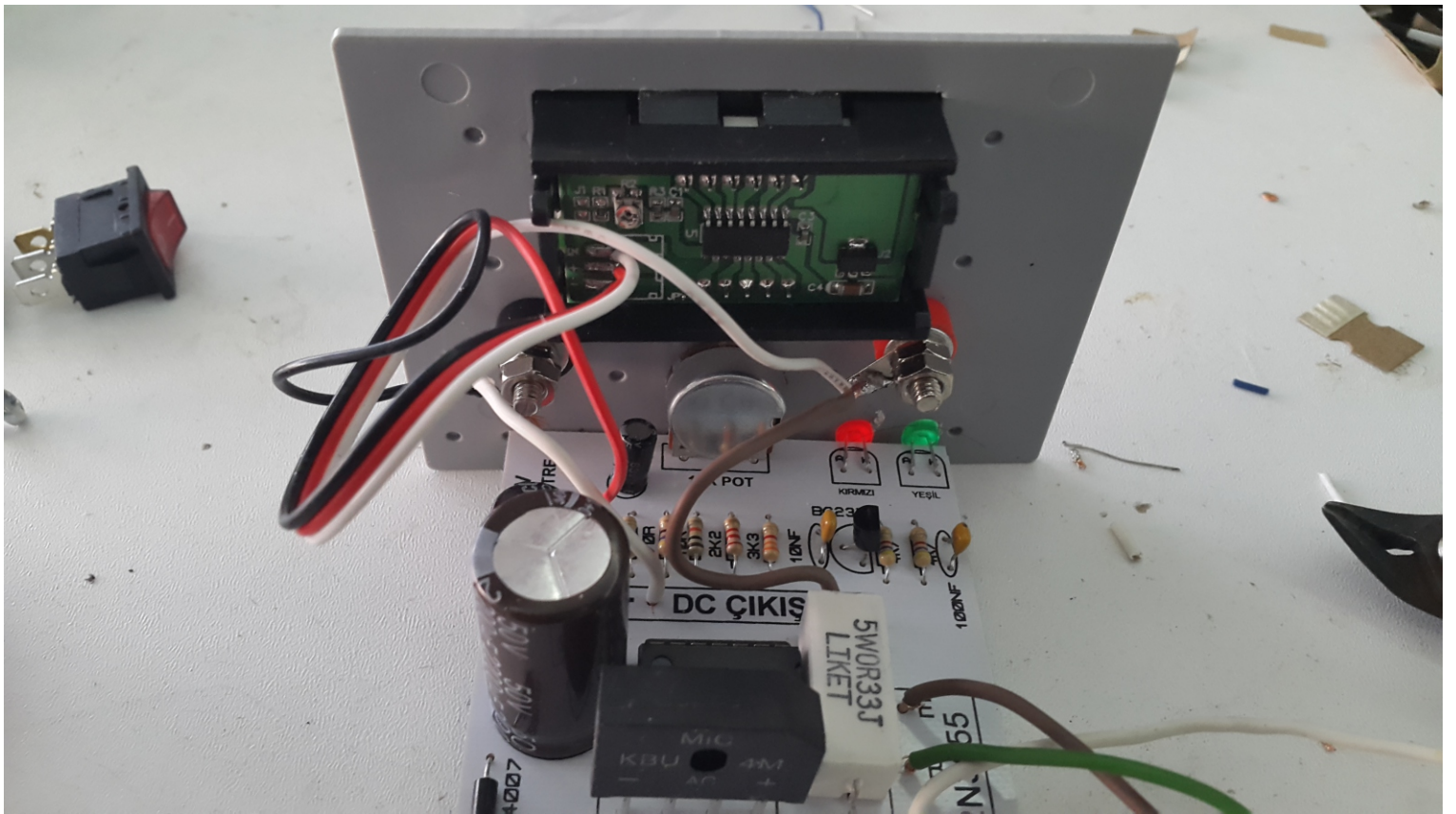
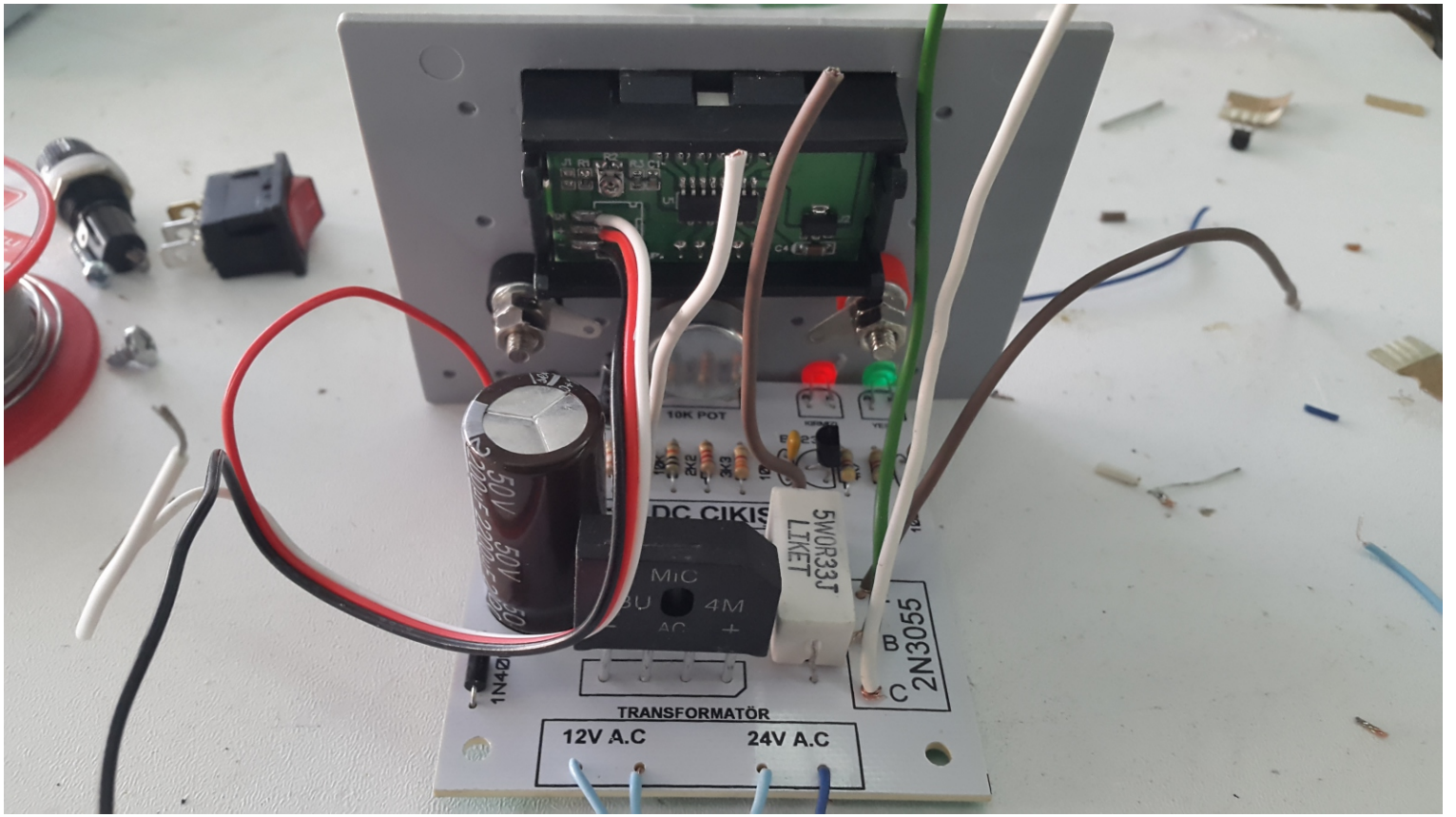

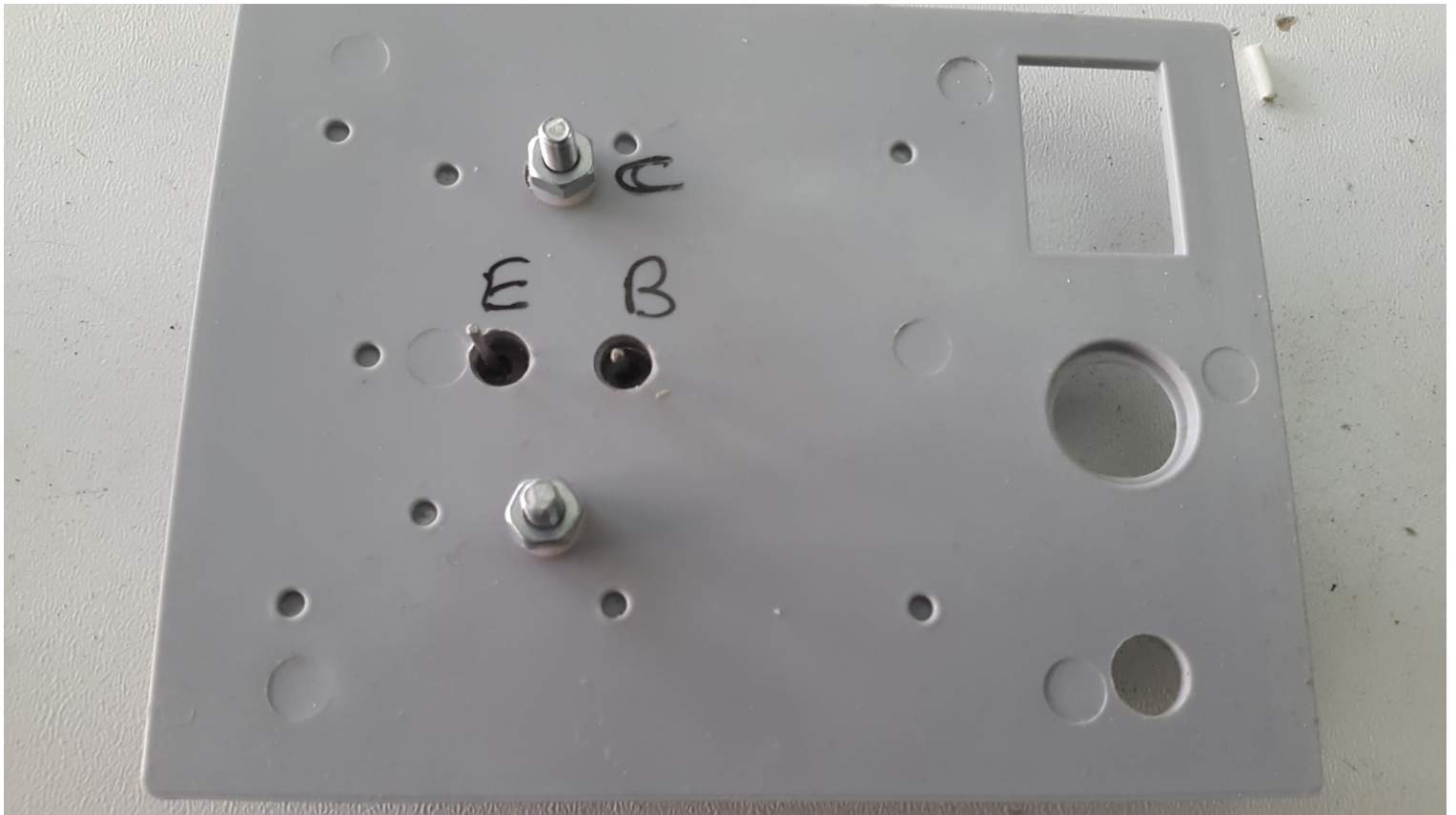

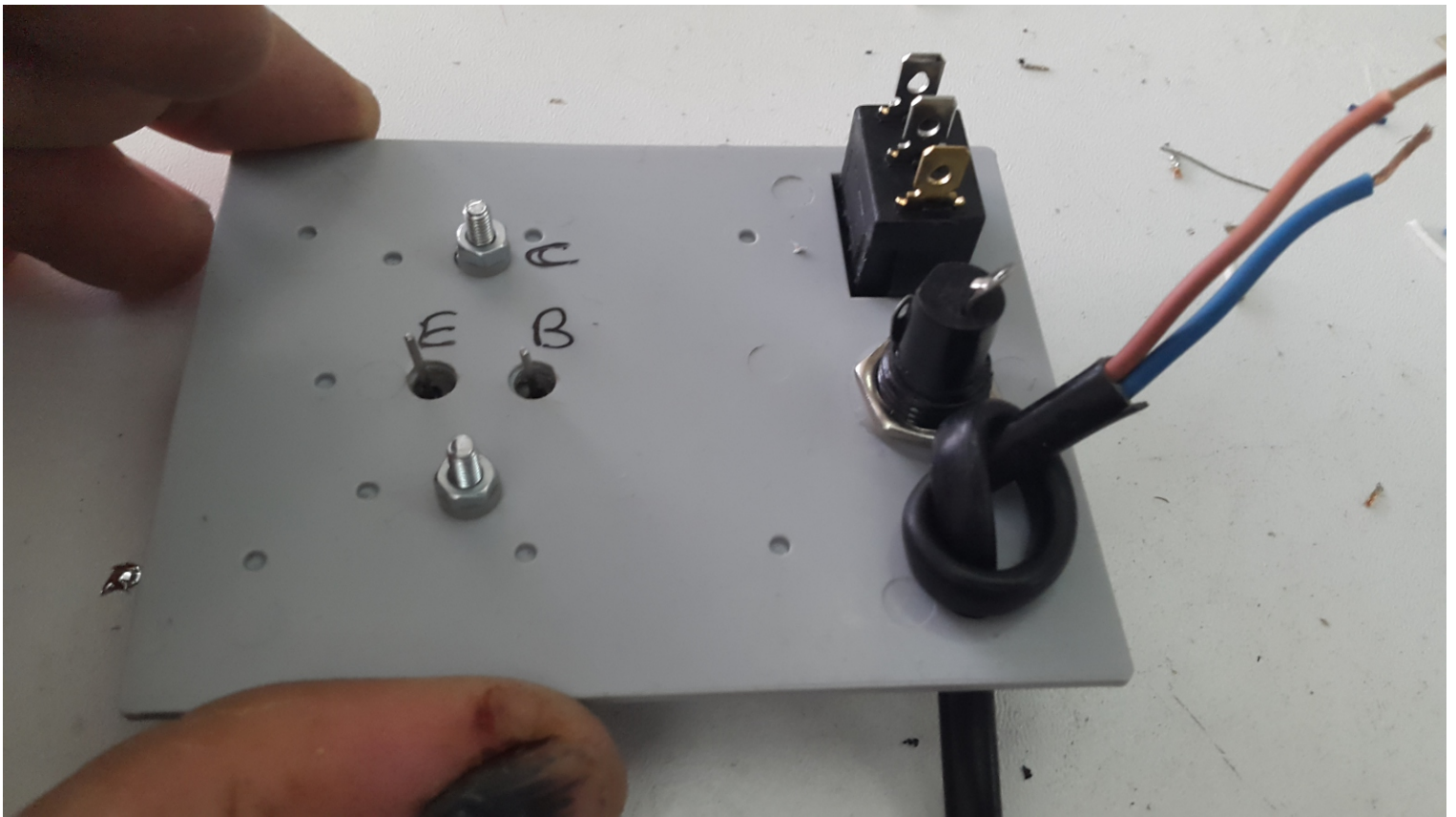

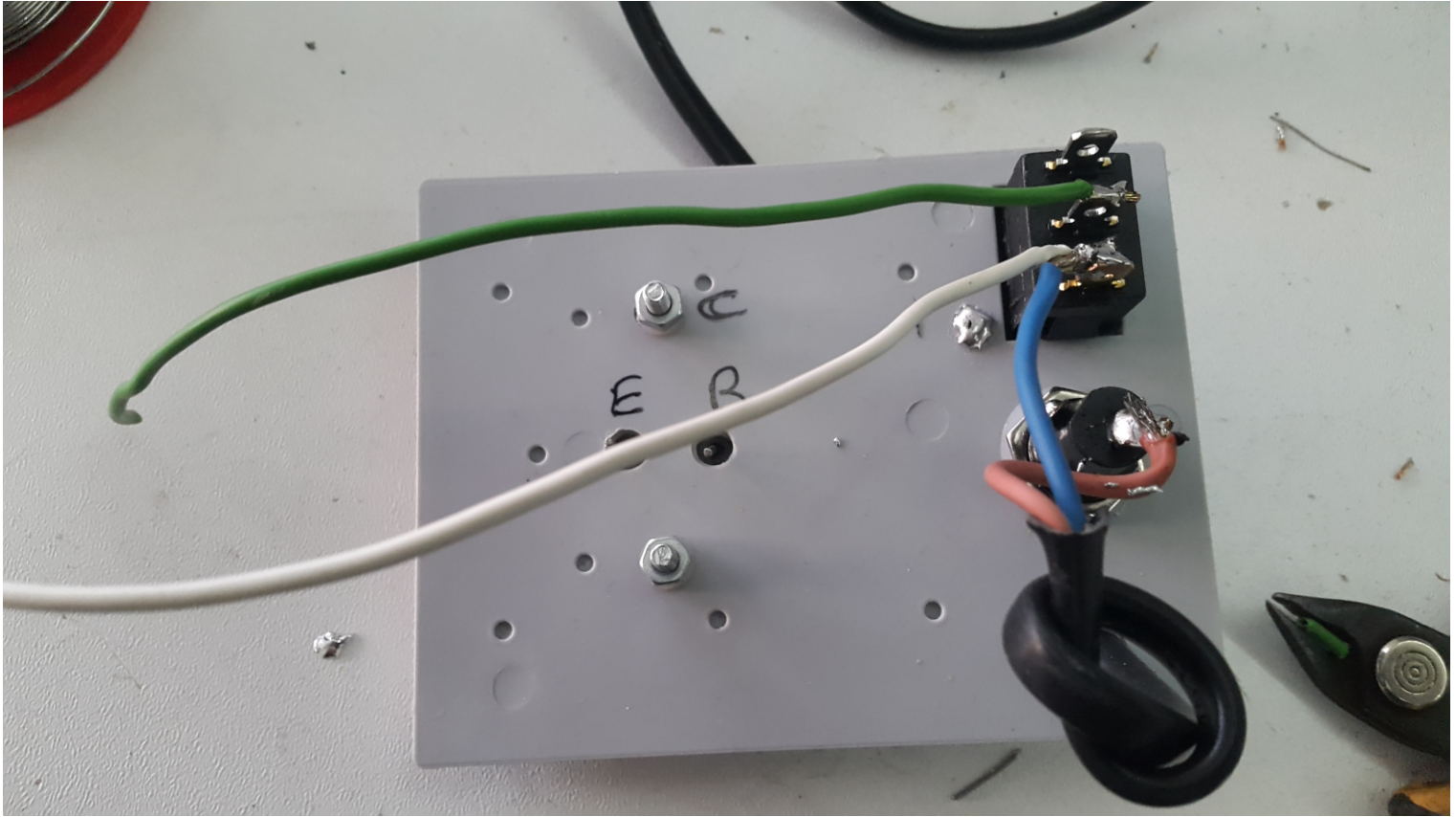
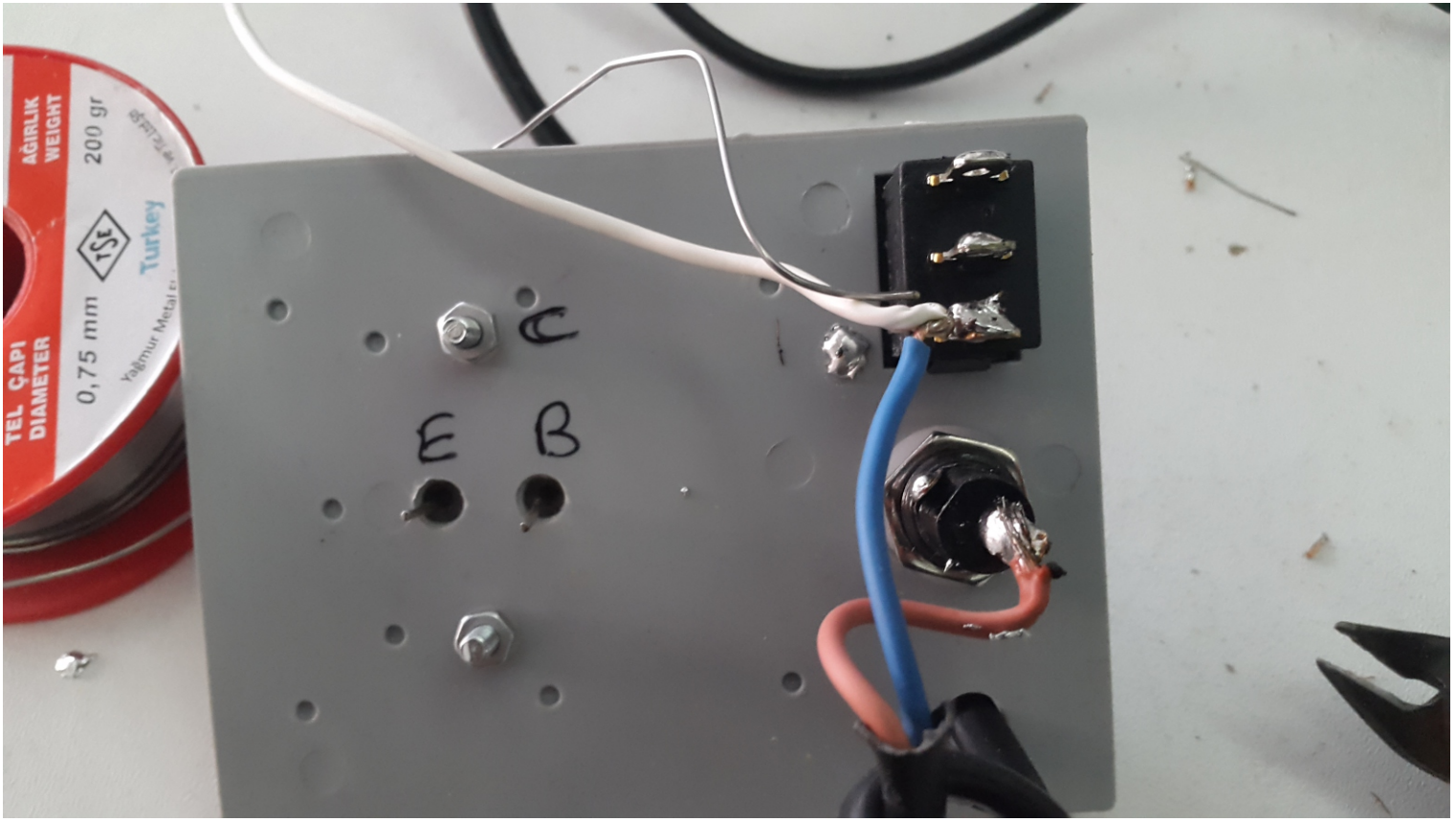

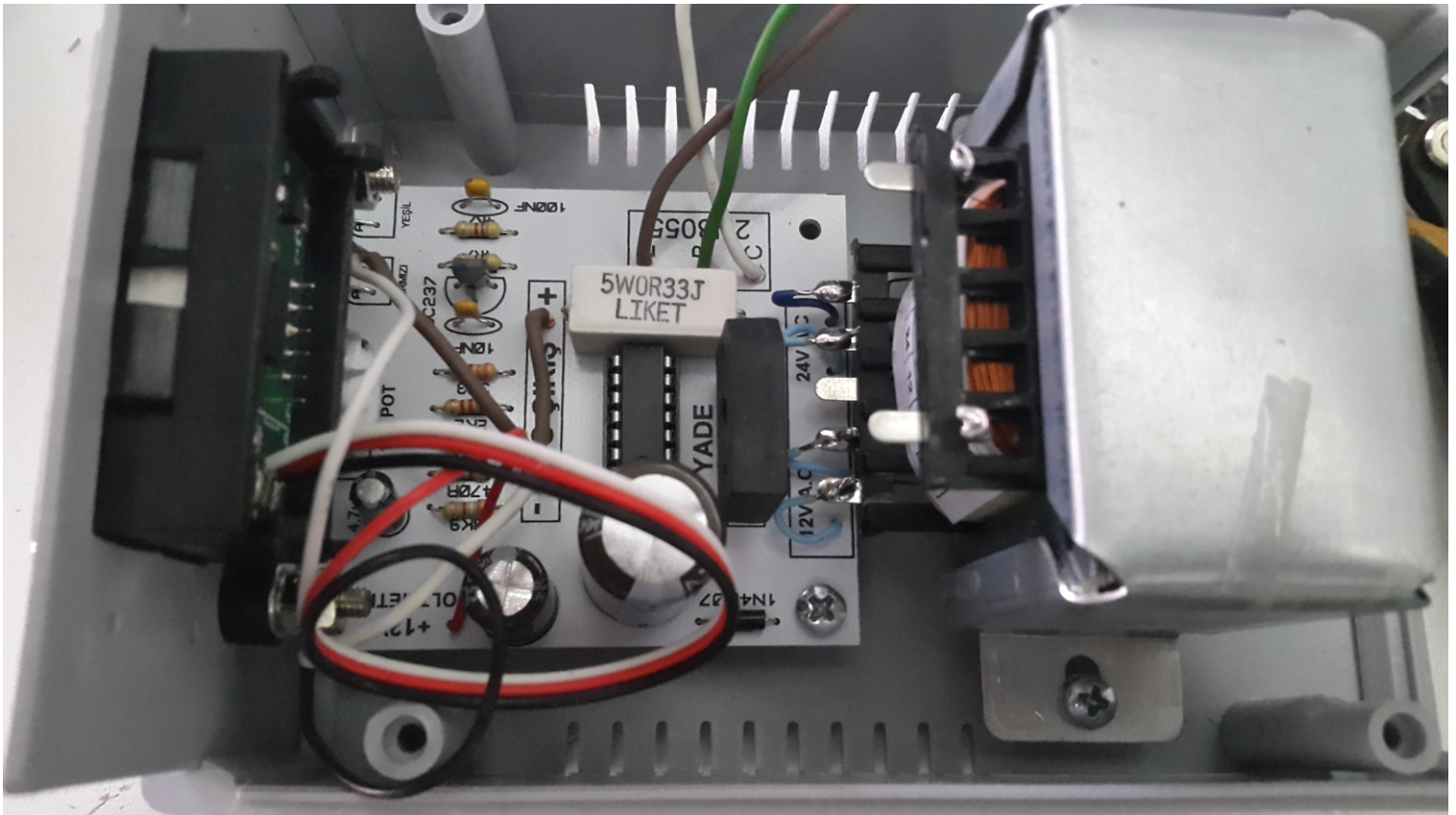
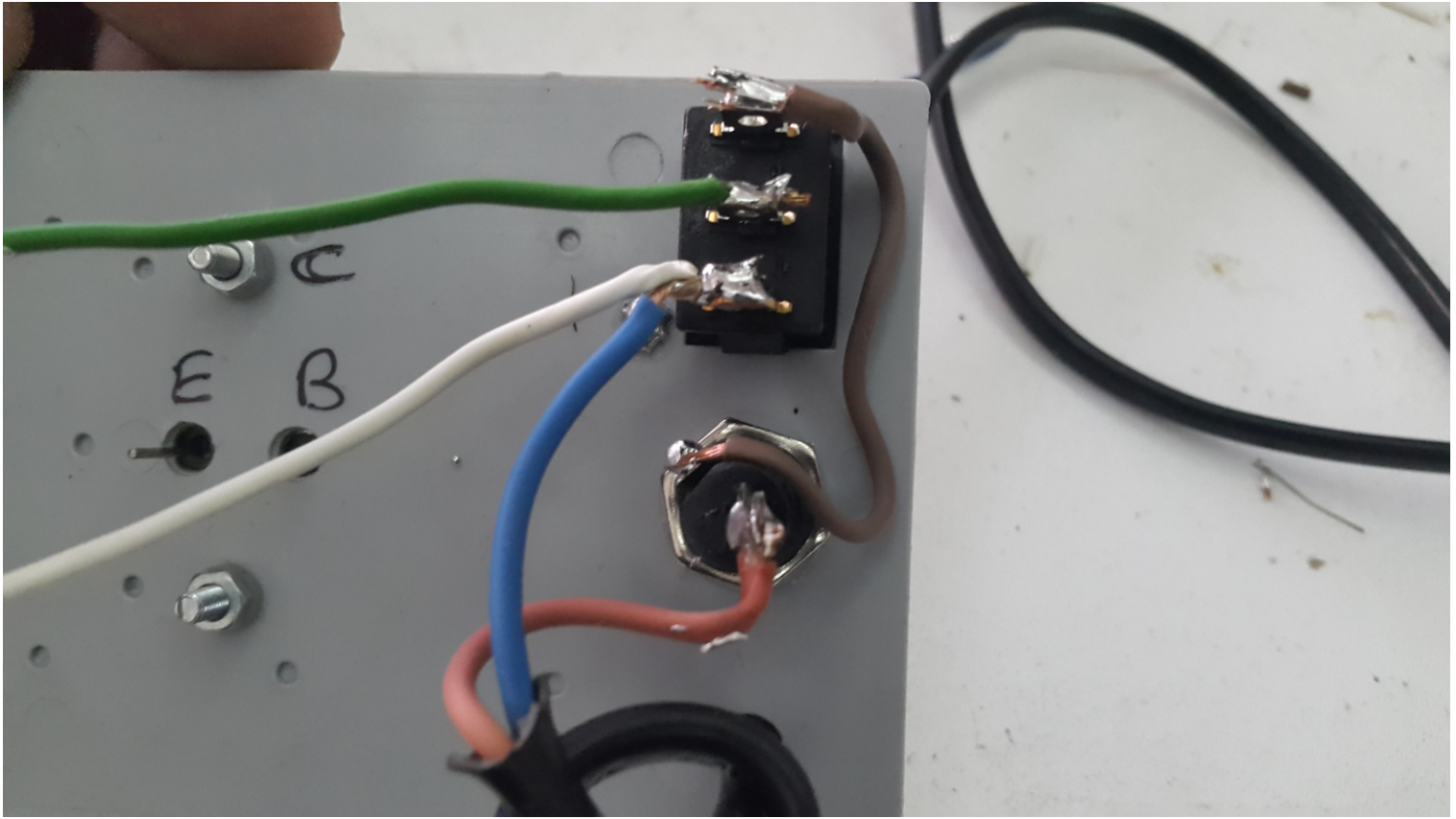

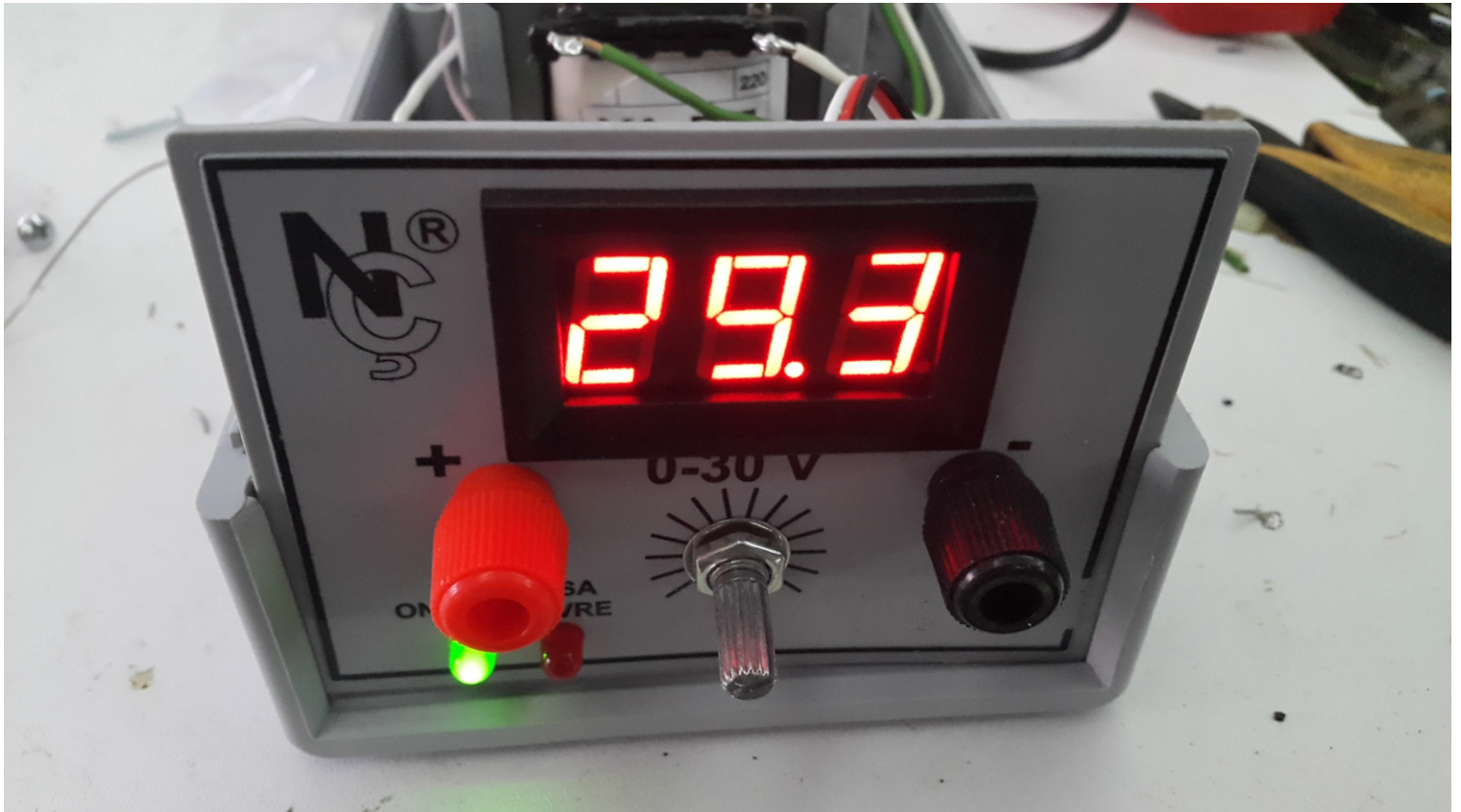
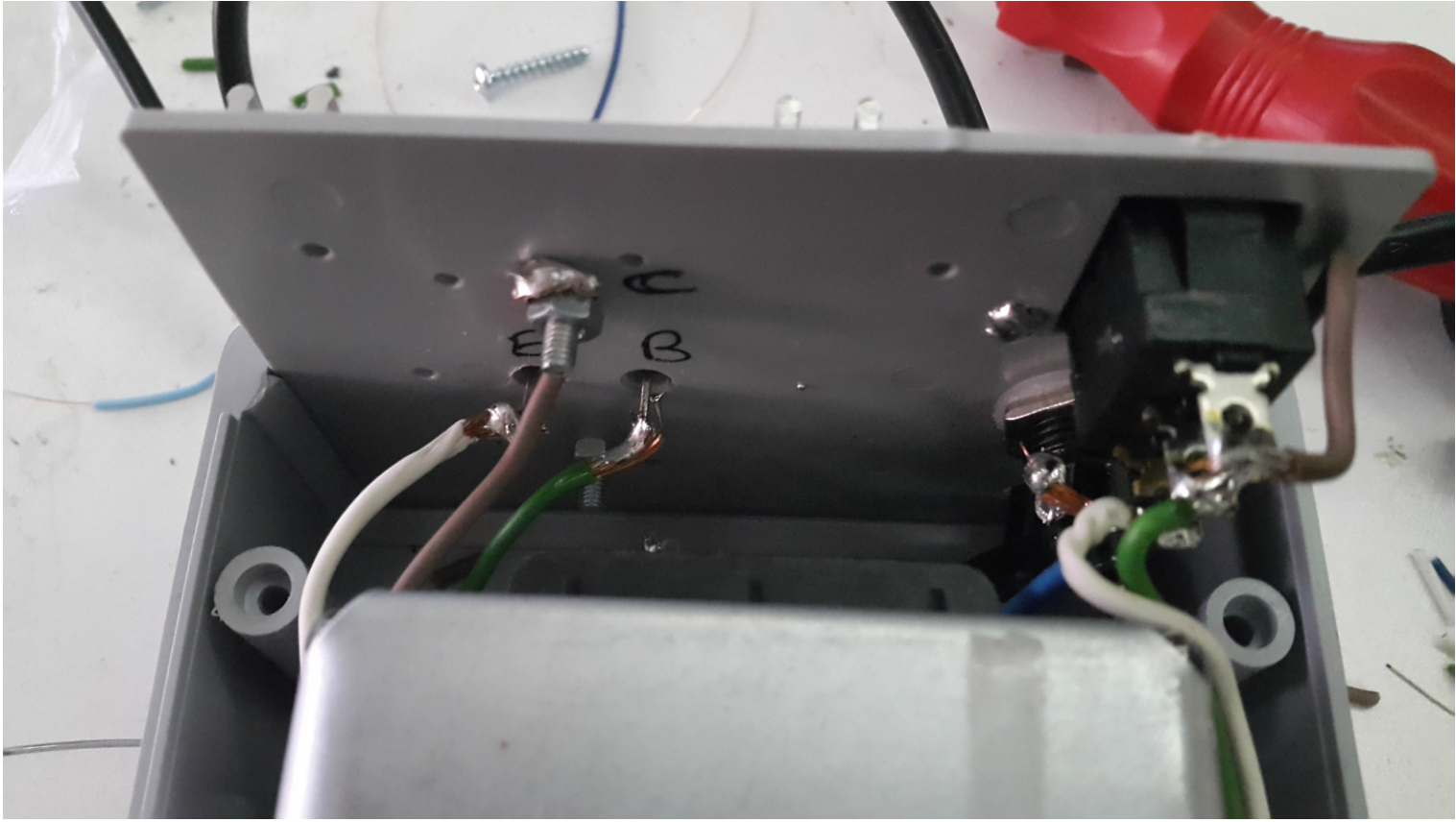

Voltmetrenin gösterdiği en yüksek değer yaklaşık 30V dur.



Voltmetrenin gösterdiği en düşük değer yaklaşık 2 V dur.

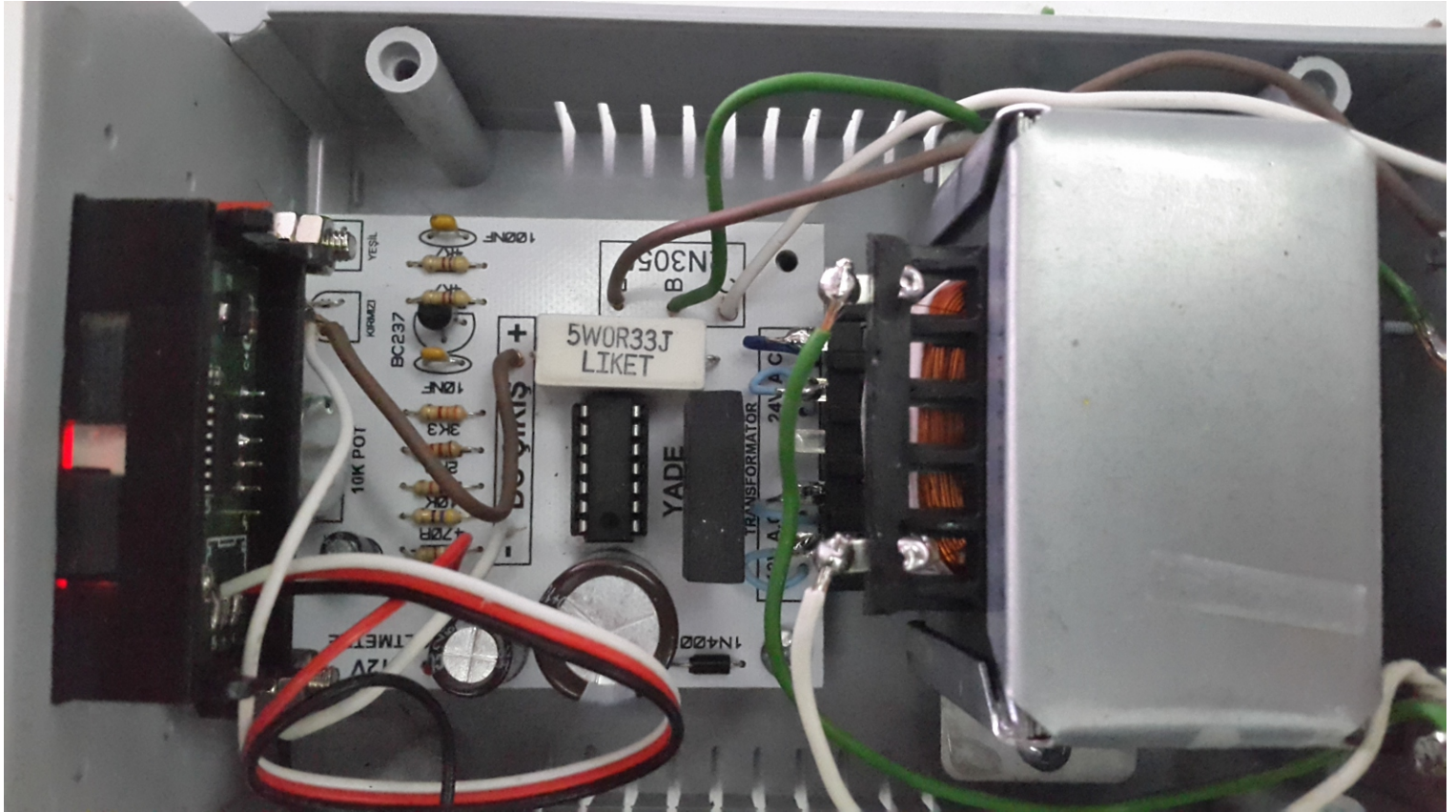

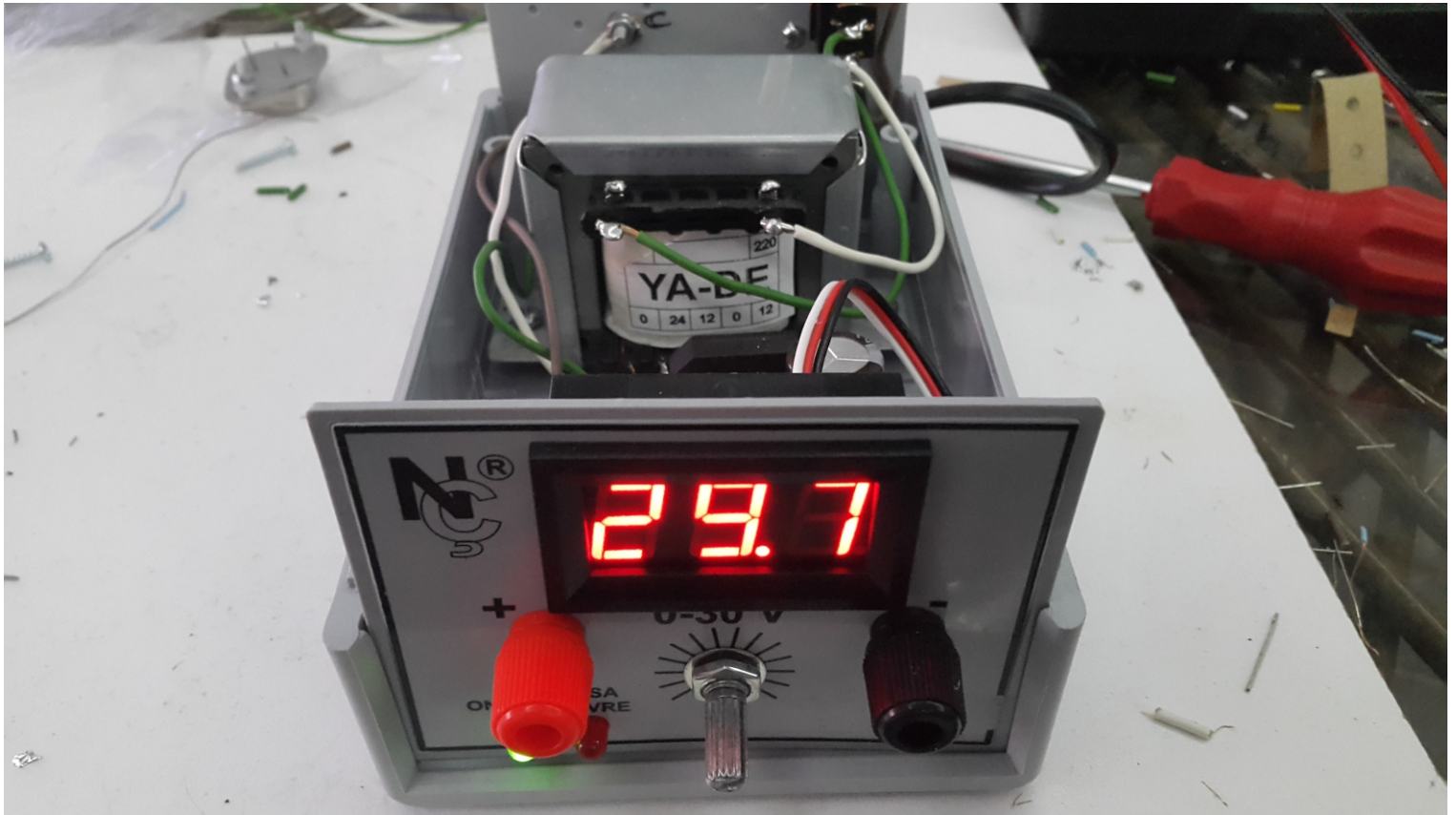



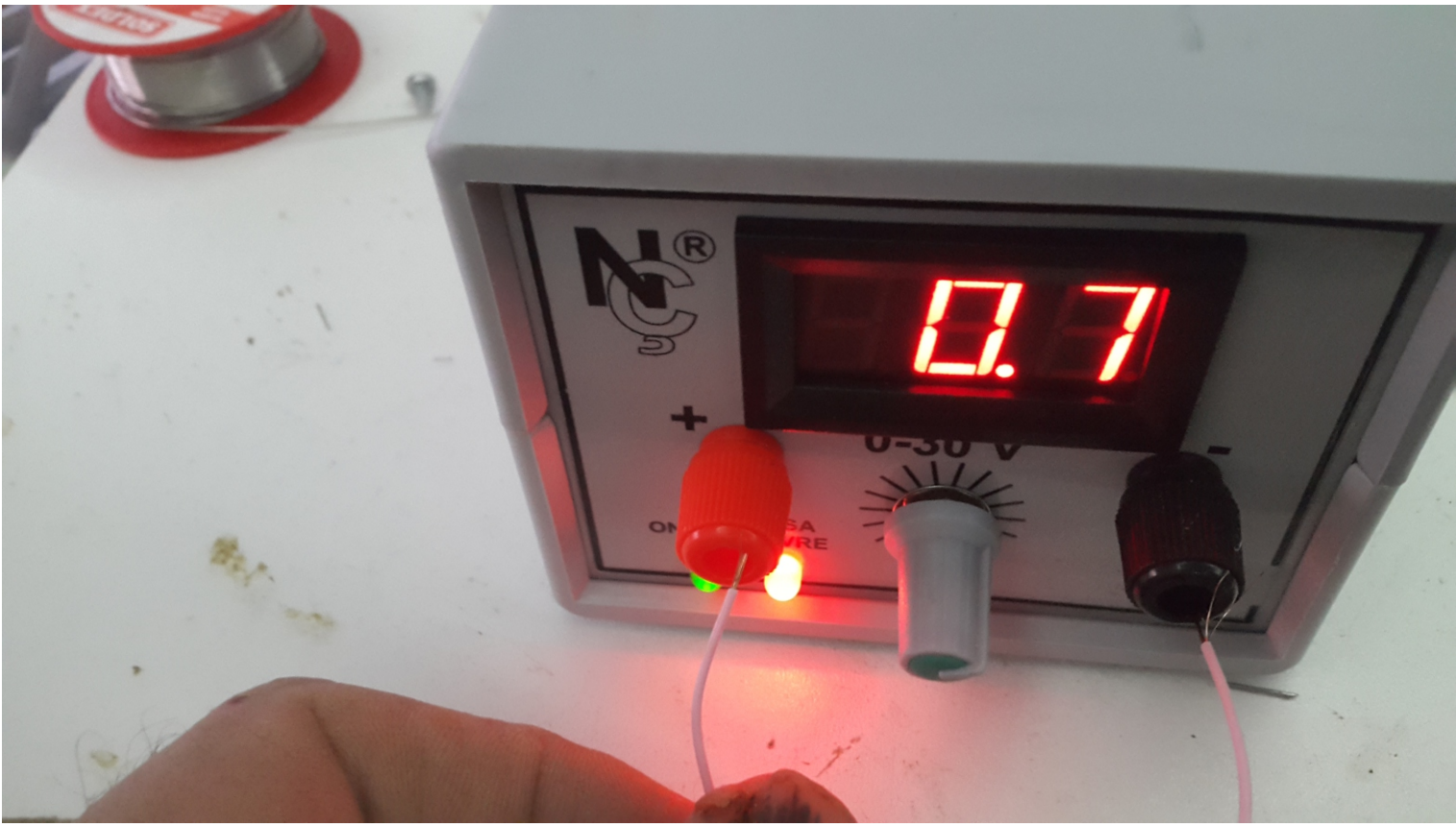

Güç kaynağının uçları kısa devre edildiğinde kırmızı led ışık verir.

